

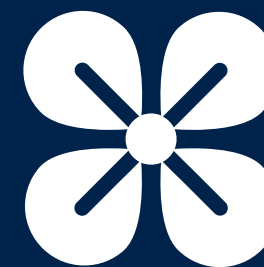

life.augmented

STPMIC1

Power management IC



STPMIC



STPMIC

STPMIC1 overview

Highly integrated PMIC for microprocessor units



KEY APPLICATIONS

- Industrial [e.g. Controls, POS, M2M interfaces, predictive maintenance]
- Home Automation
- Networking
- Medical Monitoring

High level of integration – 14 power rails

- 4 Buck DC/DC converters
- 1 Boost DC/DC converter
- 6 LDOs
- 1 voltage reference
- 2 power switches
- Provides power to the microprocessor unit as well as to external peripherals such as USB, DDR , Flash memories and other external components

Application flexibility

- Large input voltage range: from 2.8 to 5.5 V.
- Compatible with 5 V wall adaptor, USB as well as Li-Ion/Li-Po batteries
- Full programmability via I2C

Package

- QFN 44L [5 x 6 x 0.8 mm]



STPMIC1 block diagram

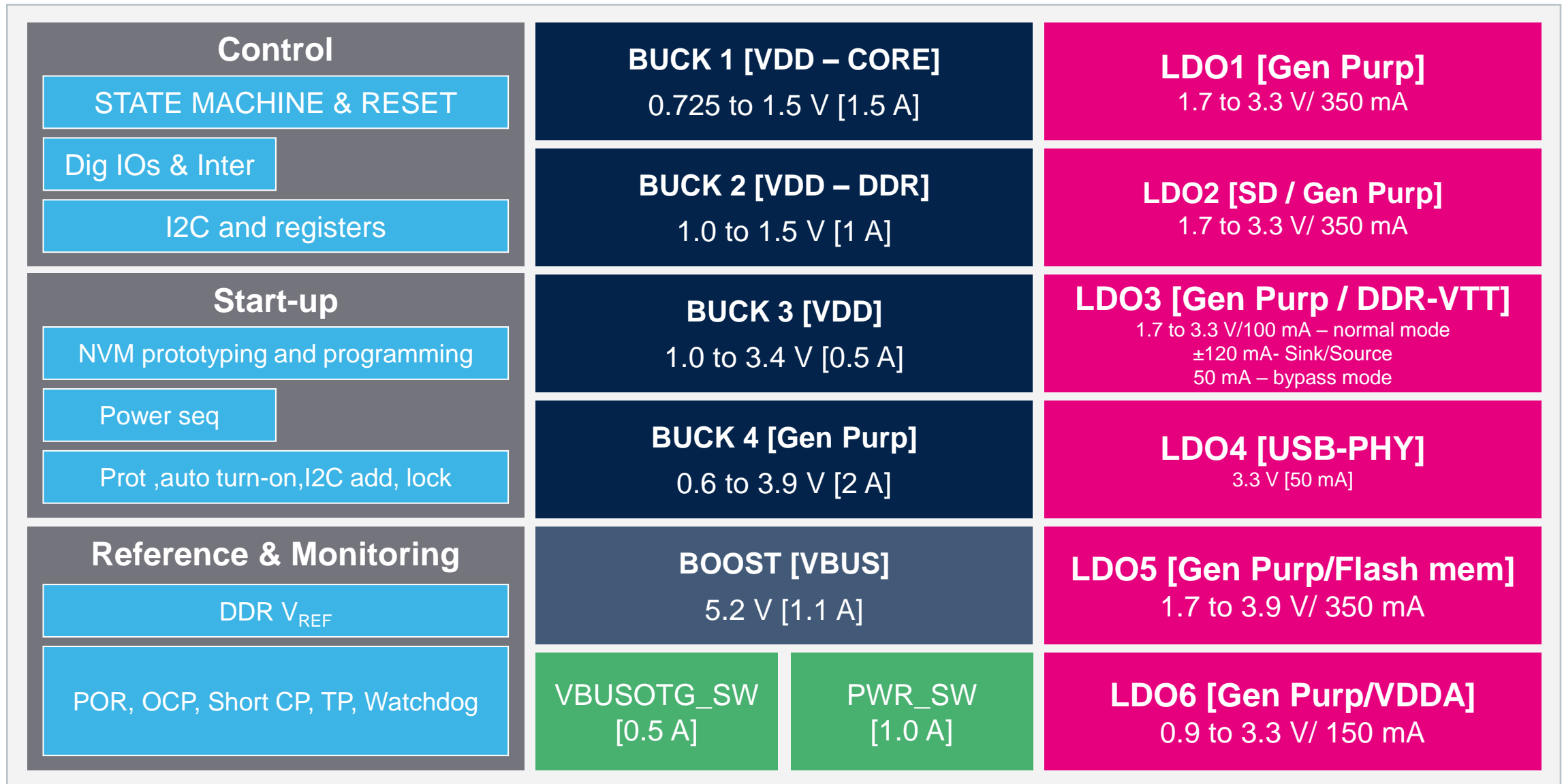



STPMIC

STPMIC1 versions

Pre-programmed
[typ when $V_{IN}=5\text{ V}$]

Pre-programmed
[typ when
 $V_{IN}=\text{battery}$]

Not pre-programmed
[custom application]

Pre-programmed
[typ when $V_{IN}=5\text{ V}$]

Pre-programmed
[typ when
 $V_{IN}=\text{battery}$]

	STPMIC1A		STPMIC1B		STPMIC1C		STPMIC1D		STPMIC1E	
	Default output Voltage [V]	Rank	Default output Voltage [V]	Rank	Default output Voltage [V]	Rank	Default output Voltage [V]	Rank	Default output Voltage [V]	Rank
LDO1	1.8	0	1.8	0	1.8	0	1.8	0	1.8	0
LDO2	1.8	0	2.9	2	1.8	0	1.8	0	1.8	0
LDO3	1.8	0	1.8	0	1.8	0	1.8	0	1.8	0
LDO4	3.3	3	3.3	3	3.3	0	3.3	3	3.3	3
LDO5	2.9	2	2.9	2	1.8	0	3.3	2	2.9	2
LDO6	1.0	0	1.0	0	1.0	0	1.0	0	1.0	0
REFDDR	0.55	0	0.55	0	0.55	0	0.55	0	0.55	0
BOOST	5.2	N/A	5.2	N/A	5.2	N/A	5.2	N/A	5.2	N/A
BUCK1	1.2	2	1.2	2	1.1	0	1.2	3	1.2	3
BUCK2	1.1	0	1.1	0	1.1	0	1.1	0	1.1	0
BUCK3	3.3	1	1.8	1	1.2	0	3.3	1	1.8	1
BUCK4	3.3	2	3.3	2	1.15	0	1.2	2	1.2	2

Rank= 0: rail not automatically turned ON

Rank= 1: rail automatically turned ON after 7 ms

Rank= 2: rail automatically turned ON after further 3 ms

Rank= 3: rail automatically turned ON after further 3 ms



life.augmented



STPMIC1 | buck converters

Main electrical characteristics

	BUCK 1	BUCK 2	BUCK 3	BUCK 4
Output Voltage	0.725 to 1.5 V	1 to 1.5 V	1 to 3.4 V	0.6 to 3.9 V
Output Voltage Steps	25 mV	50 mV	100 mV	25 mV [V _{OUT} from 0.6 to 1.3V] 50 mV [V _{OUT} from 1.3 to 1.5V] 100 mV [V _{OUT} from 1.5 to 3.9V]
I _{OUT}	1.5 A	1 A	0.5 A	2 A
100% DC	Y	Y	Y	Y
Control Method	Adaptive Constant ON-Time [in HP mode] → 2 MHz in steady state, FSW during transient allowing excellent response , high accuracy [2 %] Hysteretic [in LP mode]: low I _q [5 - 20 uA], good transient response but lower accuracy [4 %]			

Boost converter for USB-VBUS

Main electrical characteristics

O/P Voltage	V _{OUT} acc	Rated I _{OUT}	Bypass	Disch V _{OUT}	OCP	OVP
5.2 V	± 3.5 %	1.1 A	Y	Y	Y	Y

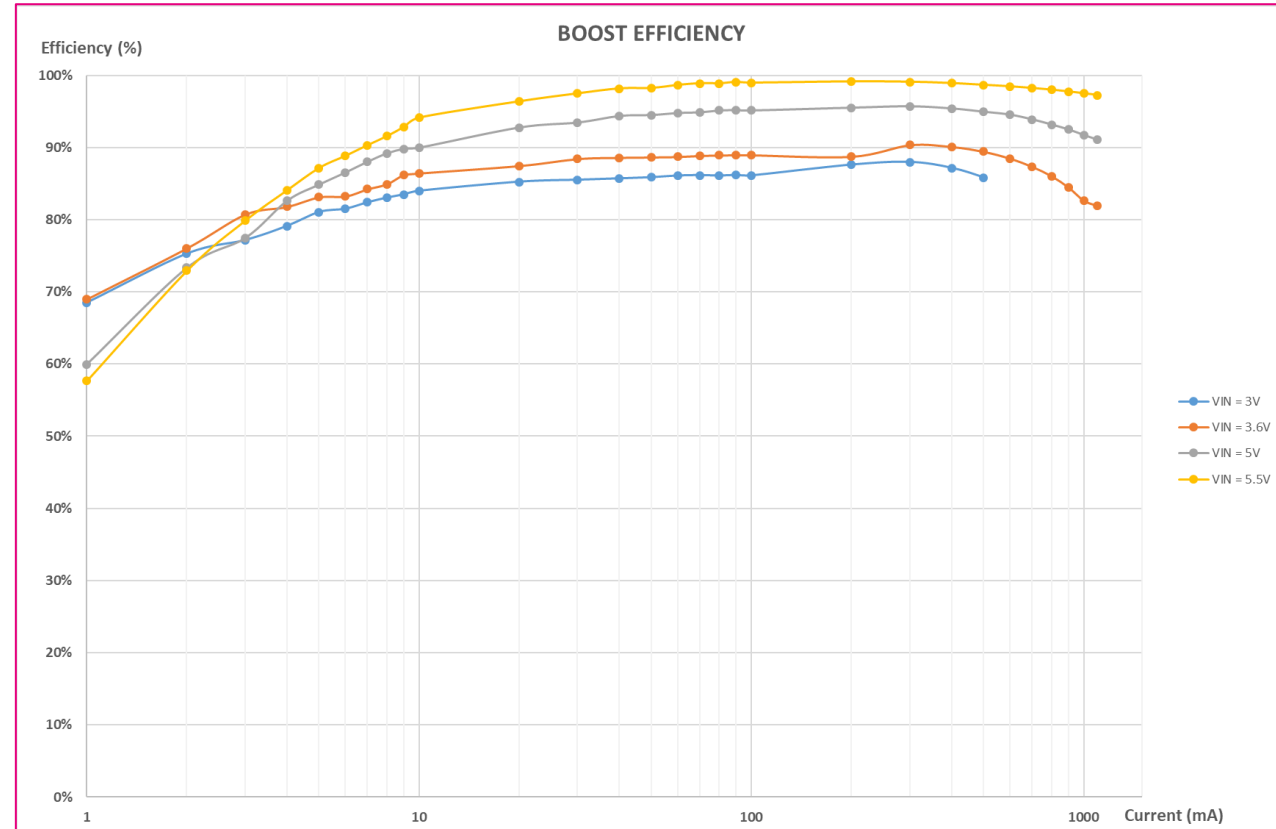
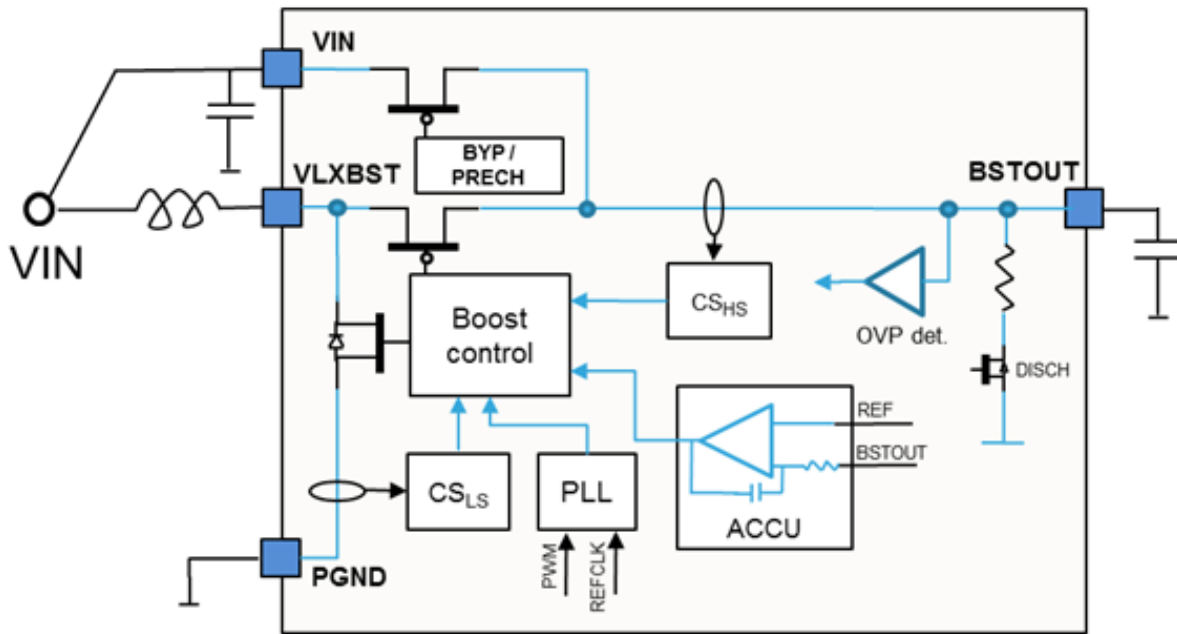

- Input voltage: 2.8 V* to 5.5 V
- Output voltage / rated output current / default output voltage / usage:
 - LDO1: 1.7 to 3.3 V | 350 mA | OFF | General Purpose
 - LDO2: 1.7 to 3.3 V | 350 mA | OFF** or 2.9 V** | General Purpose [e.g. SD-card]
 - LDO3: 1.7 to 3.3 V | 120 mA | OFF | DDR3 VTT or IpDDR2's VDD1 or General Purpose
 - LDO4: 3.3 V | 50 mA | 3.3 V | Dedicated for MPU USB PHY
 - LDO5: 1.7 to 3.9 V | 350 mA | 2.9 V | General Purpose [e.g. Flash memory / SD-CARD]
 - LDO6: 0.9 to 3.3 V | 150 mA | OFF | General Purpose
 - VREF: VOUT2/2 | 5 mA | OFF | Dedicated for DDR reference voltage
- I²C programming step: 100 mV
- Output voltage accuracy: +/- 2 %
- Programmable passive discharge resistor: inactive / active
- OCP fault flag

* LDO3 V_{IN} min= 1.8V depending of operating mode

** STPMIC1A : OFF / STPMIC1B : 2.9 V

STM32MP1 general purpose MPU

Accelerating IoT and smart industry innovation



STM32MP1

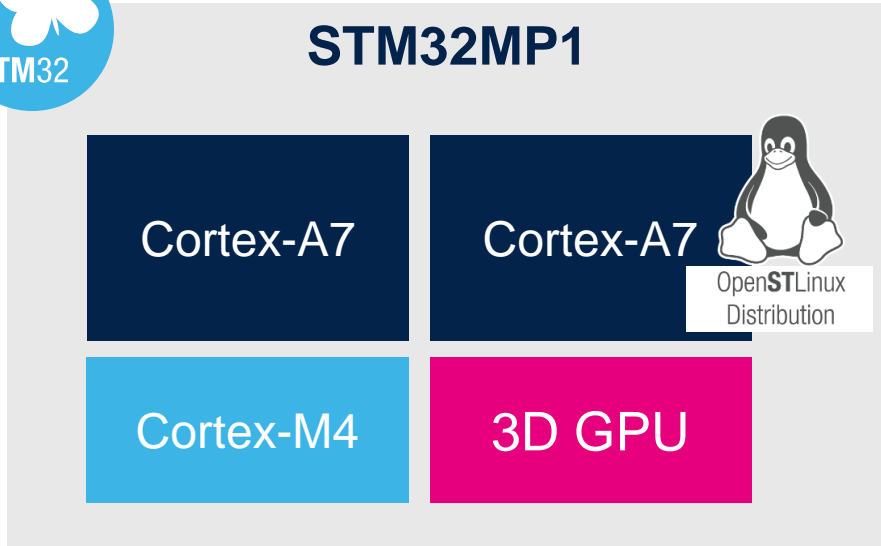

- Multicore Microprocessor running RTOS & Linux in parallel
- Suitable for industrial applications with 10-year longevity commitment
- Heterogeneous architecture [2 x Cortex-A7 + Cortex-M4 + GPU Cores]
- STM32Cube full ecosystem reuse on Arm Cortex-M4 core
- Dual Cortex-A7 with free Linux Distribution: [OpenSTLinux](#)

Target markets





STPMIC

STPMIC1 and STM32MP1

The All-In-One power management solution for STM32MP1 microprocessors

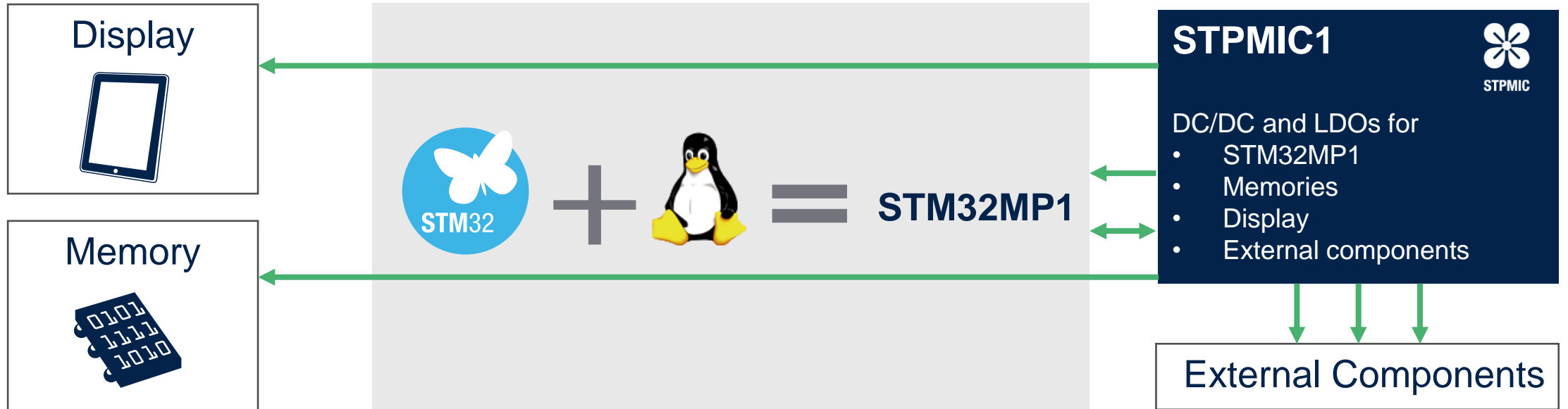

- Optimized power consumption
- BOM saving
- Smaller PCB footprint than discrete solution



STPMIC

STPMIC1 and STM32MP1

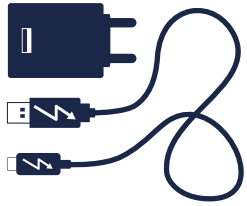

2.8 to 5.5 V

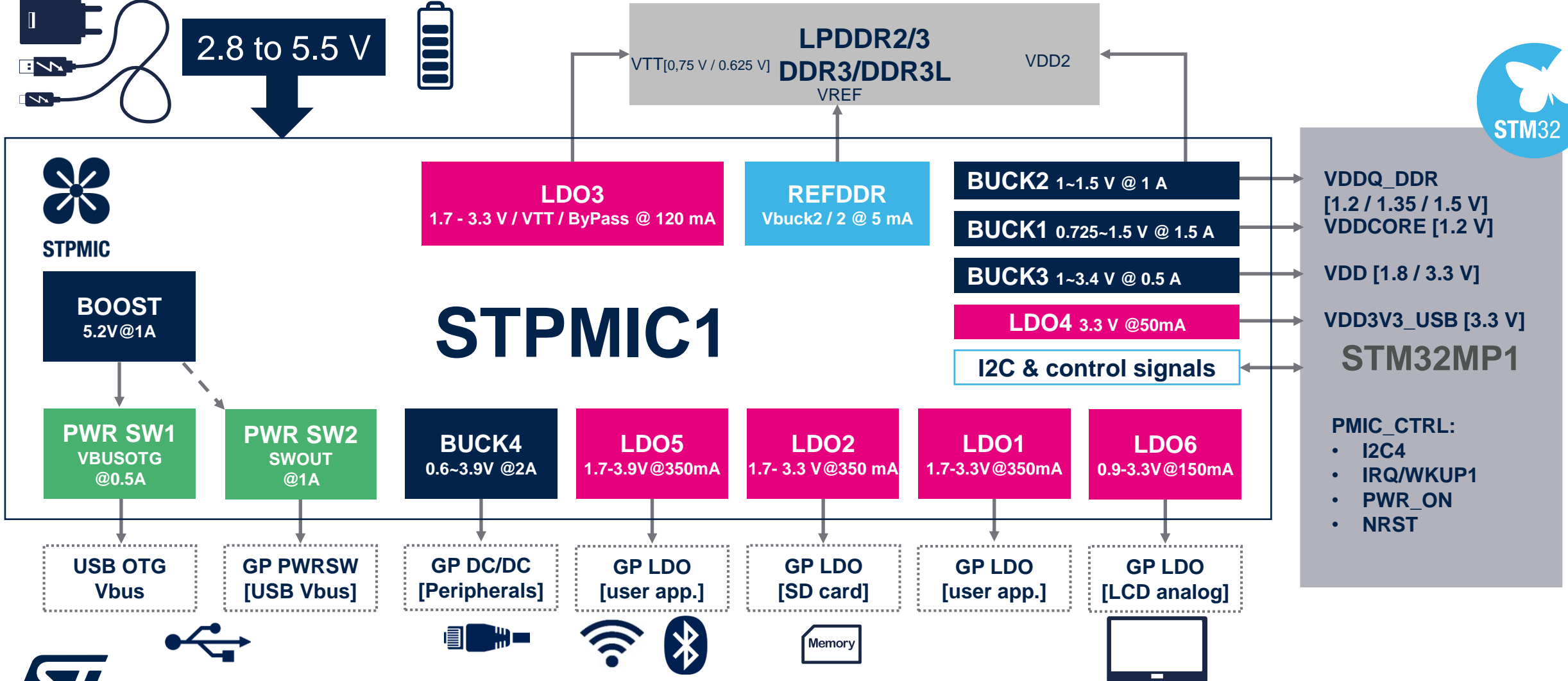



STPMIC1 IC vs. Discrete solutions

Optimized features

	STPMIC1	Discrete solution
Monitor all power rails and provide OCP, OVP, OTP features	✓	✗
Power-up / Power-down sequence	✓	✗
Voltage accuracy / settling time needed by STM32MP1 series	✓	Need an accurate component selection
Overall solution footprint (*)	✓	✗
BOM	✓	✗

* STPMIC1 PCB footprint ~300mm²
Discrete solution ~ 750mm² | 5*DC/DC~600mm² | 6*LDO~150mm²



**Home
Automation**



**Industrial
Control**



POS Terminals

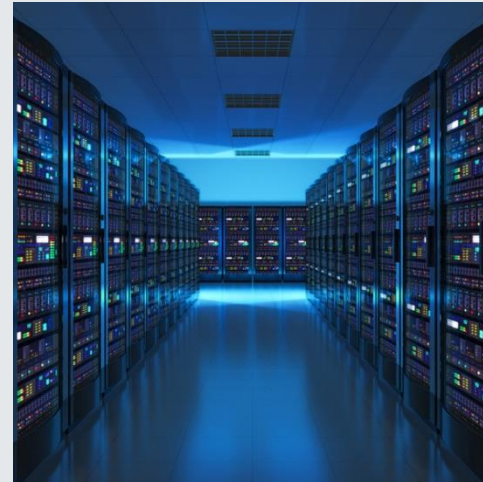

Networking



**Medical
Monitoring**



STPMIC1 for mass market

A comprehensive set of tool for validating the design on your own

STEVAL-PMIC1K1 | STPMIC1 Evaluation board

STSW-PMIC1GUI | GUI to monitor and configure STPMIC1

Technical Docs | Datasheet, Application Notes, Gerber files, ...

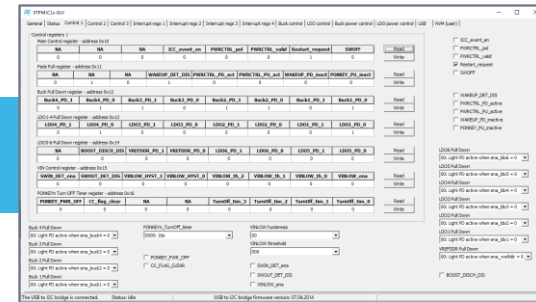

Minimum longevity commitment of 10 years





STPMIC

STPMIC1 takeaways

STPMIC1 & STM32MP1

Optimized companion PMIC for ST's STM32MP1 heterogeneous multicore microprocessors family

Best PMIC for MPU pick

Satisfies the complex power demands of highly-integrated application-processor based systems

Controls & protections beyond just delivering power

Provides power-rail monitoring and protection, handles power-up/down sequencing, and meets accuracy and settling-time specifications

Optimized application footprint

Saves board space and BOM cost vs discrete solution



life.augmented

Thank you

© STMicroelectronics - All rights reserved.

The STMicroelectronics corporate logo is a registered trademark of the STMicroelectronics group of companies. All other names are the property of their respective owners.



life.augmented