

### STEVAL-ISA114V1: 5 V / 0.8 W 30 kHz buck with the VIPer06XS

## Introduction

This document describes a 5 V - 0.16 A power supply set in buck topology with the VIPer06XS, a new offline high voltage converter by STMicroelectronics, specifically developed for non-isolated SMPS.

The features of the device include:

- 800 V avalanche rugged power section
- PWM operation at 30 kHz with frequency jittering for lower EMI
- Limiting current with adjustable set point
- On-board soft-start
- Safe auto-restart after a fault condition and low standby power consumption

The available protection includes thermal shutdown with hysteresis, delayed overload protection and open loop failure protection. All protections are in auto-restart mode.

Figure 1. STEVAL-ISA114V1 evaluation board



# Contents

<b>1</b>	<b>Adapter features</b> .....	<b>4</b>
<b>2</b>	<b>Circuit description</b> .....	<b>4</b>
<b>3</b>	<b>Bill of material</b> .....	<b>6</b>
<b>4</b>	<b>Layout</b> .....	<b>7</b>
<b>5</b>	<b>Testing the board</b> .....	<b>8</b>
5.1	Typical waveforms .....	8
5.2	Line/load regulation and output voltage ripple .....	9
5.3	Burst mode and output voltage ripple .....	10
5.4	Efficiency .....	10
5.5	Light load performance .....	11
<b>6</b>	<b>Functional check</b> .....	<b>14</b>
6.1	Startup .....	14
6.2	Overload protection .....	15
<b>7</b>	<b>Feedback loop calculation guidelines</b> .....	<b>17</b>
7.1	Transfer function .....	17
7.2	Compensation procedure for a DCM buck .....	18
<b>8</b>	<b>Thermal measurements</b> .....	<b>20</b>
<b>9</b>	<b>EMI measurements</b> .....	<b>23</b>
<b>Appendix A</b>	<b>Test equipment and measurement of efficiency and light load performance.</b> .....	<b>24</b>
A.1	Measuring input power .....	24
<b>10</b>	<b>References</b> .....	<b>27</b>
	<b>Revision history</b> .....	<b>28</b>

## List of figures

Figure 1.	STEVAL- ISA114V1 evaluation board	1
Figure 2.	Application schematic	5
Figure 3.	Layout (top)	7
Figure 4.	Layout (bottom)	7
Figure 5.	Waveforms at $V_{IN} = 115 V_{AC}$ , full load	8
Figure 6.	Waveforms at $V_{IN} = 230 V_{AC}$ , full load	8
Figure 7.	Waveforms at $V_{IN} = 80 V_{AC}$ , full load	8
Figure 8.	Waveforms at $V_{IN} = 265 V_{AC}$ , full load	8
Figure 9.	Line regulation	9
Figure 10.	Load regulation	9
Figure 11.	Output voltage ripple at 115 $V_{AC}$ , full load	9
Figure 12.	Output voltage ripple at 230 $V_{AC}$ , full load	9
Figure 13.	Output voltage ripple at 115 $V_{AC}$ , no load	10
Figure 14.	Output voltage ripple at 230 $V_{AC}$ , no load	10
Figure 15.	Active mode efficiency vs. $V_{IN}$ and comparison with CoC4 and DOE	11
Figure 16.	$P_{IN}$ vs. $V_{IN}$ @ no load and light load	12
Figure 17.	$P_{IN}$ @ $P_{OUT} = 0.25 W$	13
Figure 18.	Startup at $V_{IN} = 115 V_{AC}$ , full load	14
Figure 19.	Startup at $V_{IN} = 115 V_{AC}$ , full load, zoom	14
Figure 20.	Startup at $V_{IN} = 230 V_{AC}$ , full load	14
Figure 21.	Startup at $V_{IN} = 230 V_{AC}$ , full load, zoom	14
Figure 22.	Output short-circuit applied: OLP tripping	15
Figure 23.	Output short-circuit maintained: OLP steady-state	15
Figure 24.	Output short-circuit maintained: OLP steady-state (zoom)	16
Figure 25.	Output short-circuit removal and converter restart	16
Figure 26.	Control loop block diagram	17
Figure 27.	Thermal measurement @ $V_{IN} = 80 V_{AC}$ , full load	20
Figure 28.	Thermal measurement @ $V_{IN} = 115 V_{AC}$ , full load	21
Figure 29.	Thermal measurement @ $V_{IN} = 230 V_{AC}$ , full load	21
Figure 30.	Thermal measurement @ $V_{IN} = 265 V_{AC}$ , full load	22
Figure 31.	Average measurement at full load, 115 $V_{AC}$	23
Figure 32.	Average measurement at full load, 230 $V_{AC}$	23
Figure 33.	Connections of the UUT to the wattmeter for power measurements	24
Figure 34.	Switch in position 1 - setting for standby measurements	25
Figure 35.	Switch in position 2 - setting for efficiency measurements	25

# 1 Adapter features

The electrical specifications of the evaluation board are listed in [Table 1](#)

**Table 1. Electrical specifications**

Parameter	Symbol	Value
Input voltage range	$V_{IN}$	[80 V <sub>AC</sub> ; 265 V <sub>AC</sub> ]
Output voltage	$V_{OUT}$	5 V
Max. output current	$I_{OUT}$	0.16 A
Precision of output regulation	$\Delta V_{OUT\_LF}$	±5%
High frequency output voltage ripple	$\Delta V_{OUT\_HF}$	50 mV
Max. ambient operating temperature	$T_{AMB}$	60 °C

# 2 Circuit description

The converter schematic is given in [Figure 2](#). The input section includes a resistor R1 for inrush current limiting, a diode D1 and a Pi filter (C1, L1, C2) for rectification and EMC suppression.

The FB pin is the inverting input of the internal transconductance error amplifier, internally referenced to 3.3 V. This allows the output voltage value to be set in a simple way through the R4-R5 voltage divider between the output terminal and the FB pin, according to the following equation:

### Equation 1

$$V_{OUT} = 3.3V \cdot \left(1 + \frac{R5}{R4}\right)$$

where R4 has been split into R4a and R4b; and R5 into R5a and R5b so to allow a better tuning of the output voltage value.

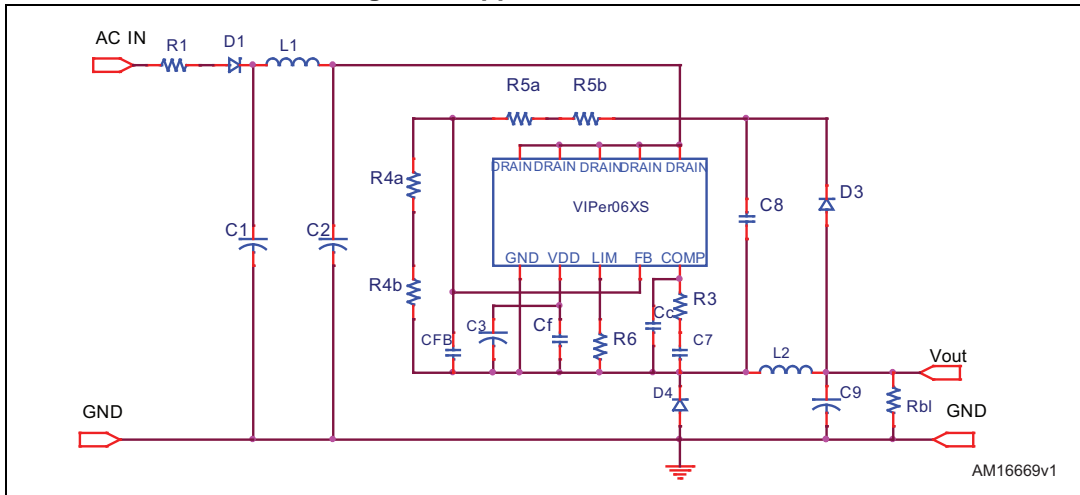
The compensation network is connected between the COMP pin (which is the output of the error amplifier) and the GND pin and is made up of Cc, R3 and C7.

The bleeder resistor Rbl provides about 1 mA minimum load, in order to avoid overvoltage when the output load is disconnected. Its value is a trade-off between output voltage increase and power consumption rise in no load.

At power-up the DRAIN pin supplies the internal HV startup current generator which charges the C3 capacitor up to  $V_{DDon}$  (13 V typical). At this point, the power MOSFET starts switching, the generator is turned off and the IC is powered by the energy stored in C3, waiting for  $V_{OUT}$  reaches its steady-state value. In this evaluation board, the IC is biased through the internal high voltage startup current generator, which is automatically turned on as the  $V_{DD}$  voltage drops down to  $V_{DDCSon}$  and switched off as  $V_{DD}$  is charged up to  $V_{DDon}$ .

This is referred to "self-biasing" and leads to higher power dissipation, but reduces the overall BOM cost.

Figure 2. Application schematic



### 3 Bill of material

**Table 2. Bill of material**

Name	Value	Description	Footprint	Manufacturer
C1	2.2 $\mu$ F, 400 V	Electrolytic capacitor		Saxon
C2	2.2 $\mu$ F, 400 V	Electrolytic capacitor		Saxon
C3	2.2 $\mu$ F, 25 V	Ceramic capacitor	SMD: 0805	Murata
CFB	not mounted	Ceramic capacitor	SMD: 0805	
Cf	100 nF, 50 V	Ceramic capacitor	SMD: 0805	Murata
Cc	n.c	Ceramic capacitor	SMD: 0805	
C7	22 nF, 25 V	Ceramic capacitor	SMD: 0805	Murata
C8	100 nF, 50 V	Ceramic capacitor	SMD: 0805	Murata
C9	100 $\mu$ F, 25 V	Electrolytic capacitor		Rubycon, ZL series
D1	1N4007	High voltage rectifier	DO-41	Fairchild
D3	STTH1L06	High voltage ultra fast rectifier	SMB (SOD87)	ST
D4	STTH1L06	High voltage ultra fast rectifier	SMB (SOD87)	ST
Daux	not mounted	Small signal diode		
IC	VIPer06XS	High voltage converter	SSO-10	ST
L1	1 mH	Input filter inductor	SMD	Epcos
L2	RFB0810-681	0.68 mH power inductor		Coilcraft
R1	22 ohm	1 W resistor		Panasonic
R3	1 kohm, 1%	1/4 W resistor	SMD: 0805	Panasonic
R4a	1.5 kohm, 1%	1/4 W resistor	SMD: 0805	Panasonic
R4b	22 kohm	1/4 W resistor	SMD: 0805	
R5a	15 kohm	1/4 W resistor	SMD: 0805	
R5b	0 ohm, 1%	1/4 W resistor	SMD: 0805	Panasonic
R6	not mounted	1/4 W resistor	SMD: 0805	
Rbl	10 kohm, 1%	1/4 W resistor	SMD: 0805	Panasonic

# 4 Layout

Figure 3. Layout (top)

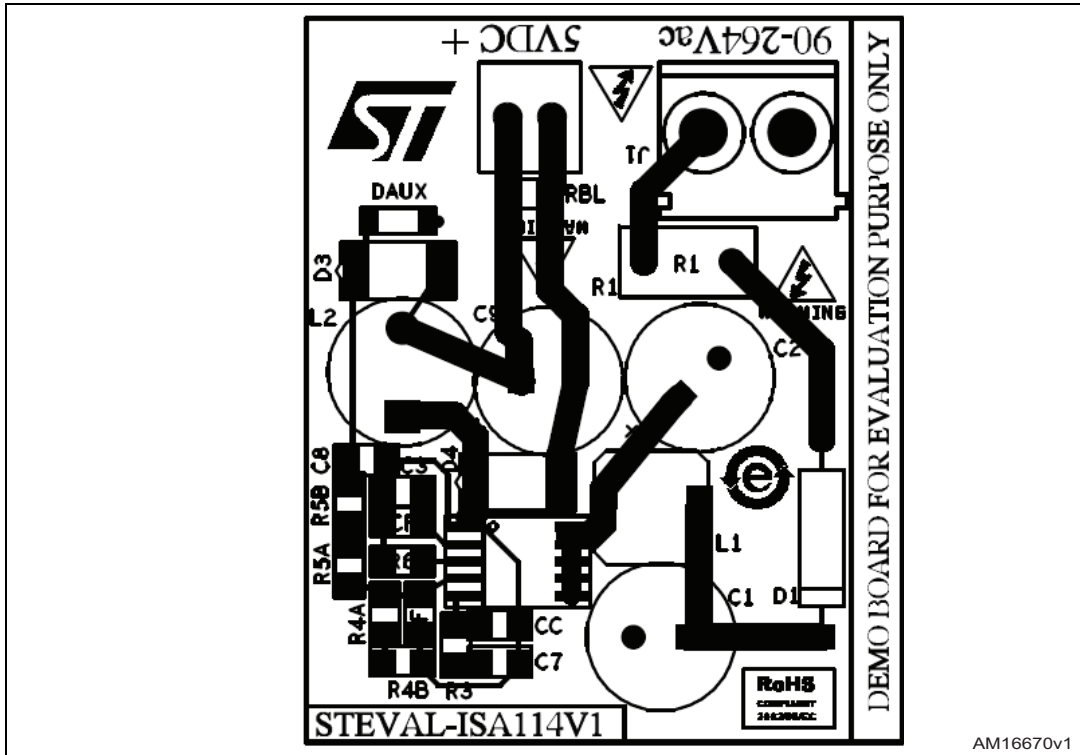
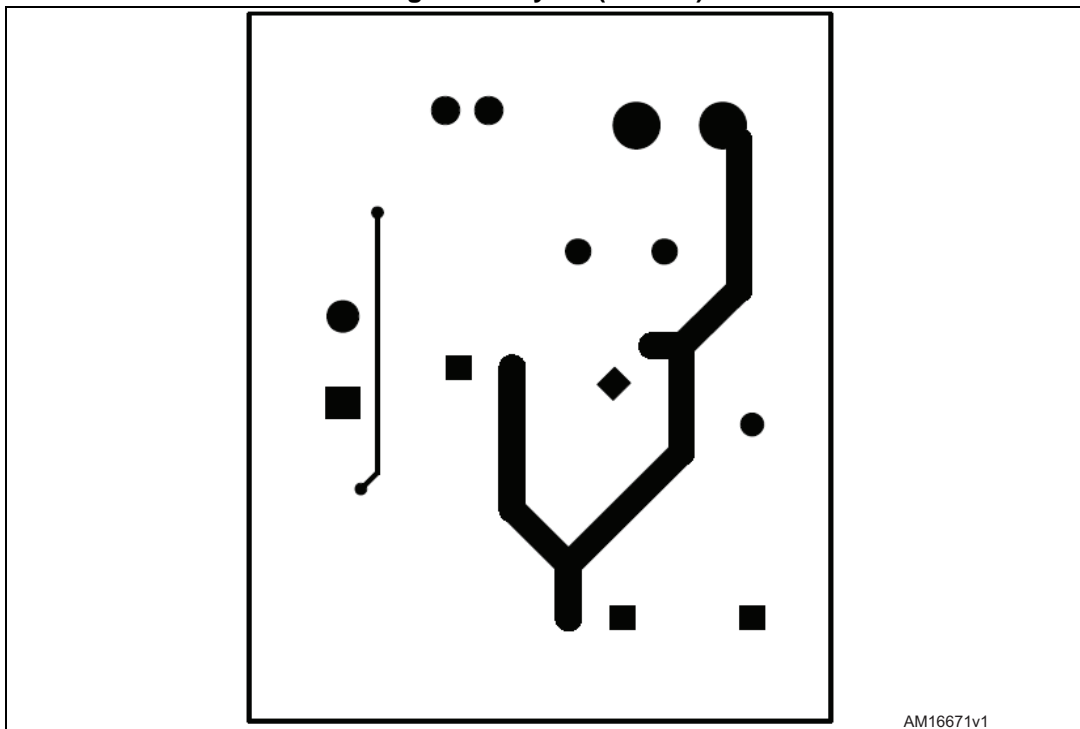


Figure 4. Layout (bottom)



## 5 Testing the board

### 5.1 Typical waveforms

GND voltage and the current across the inductor L2 (I\_L2) in full load condition are shown for the two nominal input voltages in [Figure 5](#) and [Figure 6](#), and for minimum and maximum input voltage in [Figure 7](#) and [Figure 8](#) respectively.

Figure 5. Waveforms at  $V_{IN} = 115 V_{AC}$ , full load

Figure 6. Waveforms at  $V_{IN} = 230 V_{AC}$ , full load

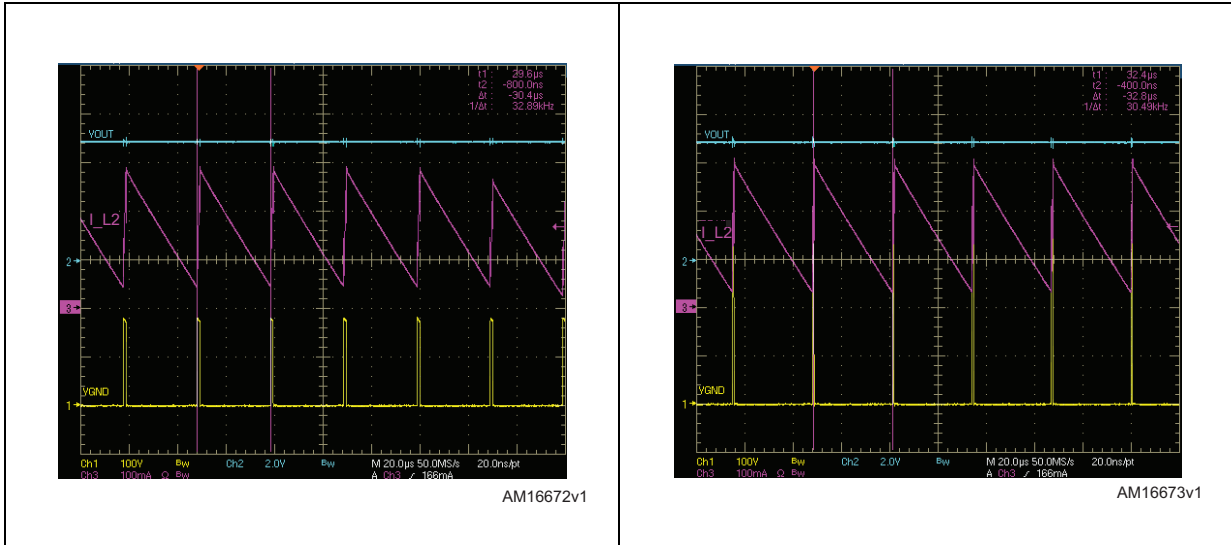
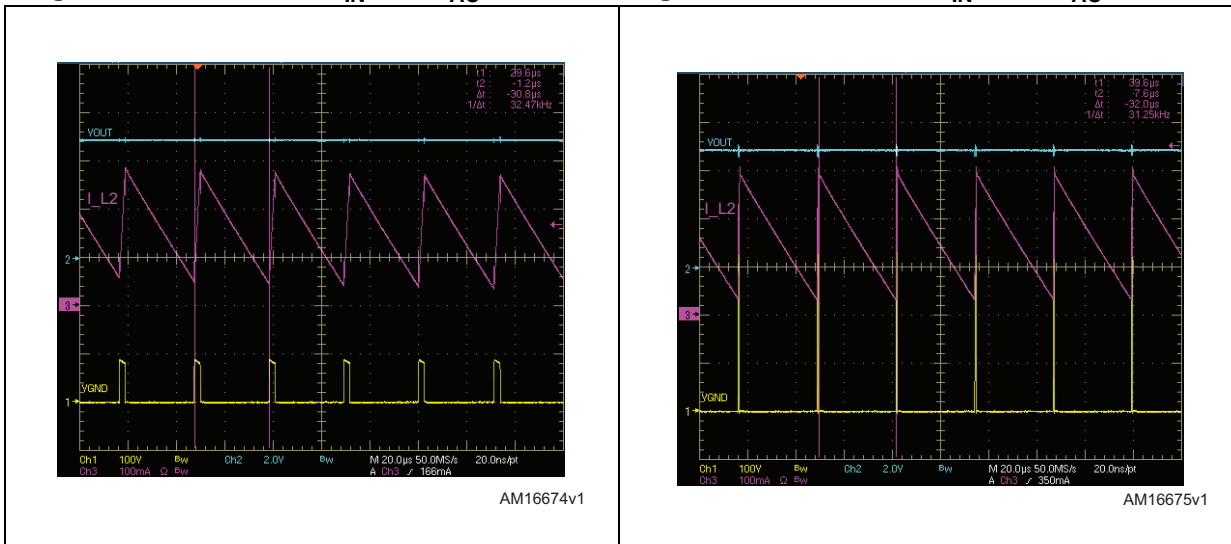


Figure 7. Waveforms at  $V_{IN} = 80 V_{AC}$ , full load

Figure 8. Waveforms at  $V_{IN} = 265 V_{AC}$ , full load





## 5.2 Line/load regulation and output voltage ripple

The output voltage of the board has been measured in different lines and load conditions. The results are shown in [Figure 9](#) and [Figure 10](#).

Figure 9. Line regulation

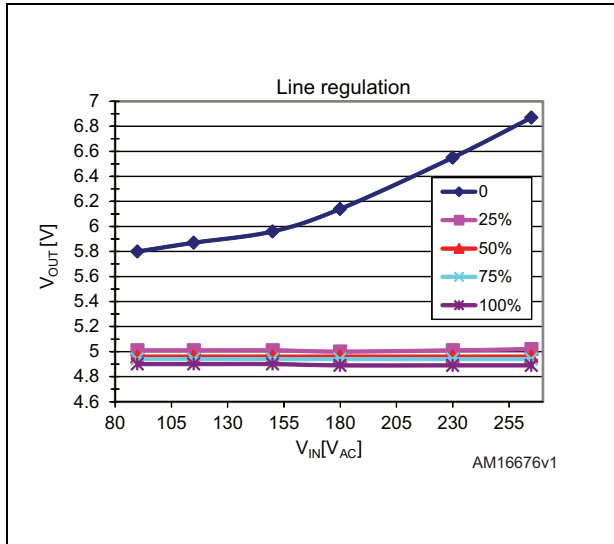
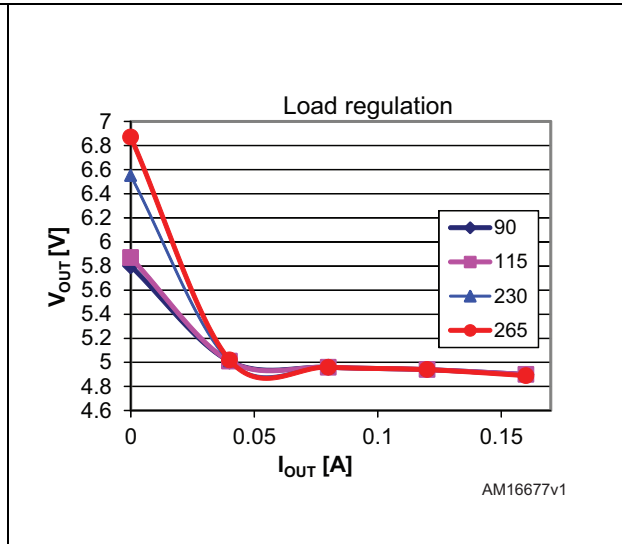


Figure 10. Load regulation



The output voltage ripple in full load condition is shown in [Figure 11](#) at  $V_{in} = 115 V_{AC}$  and [Figure 12](#) at  $V_{in} = 230 V_{AC}$ .

Figure 11. Output voltage ripple at 115 V<sub>AC</sub>, full load

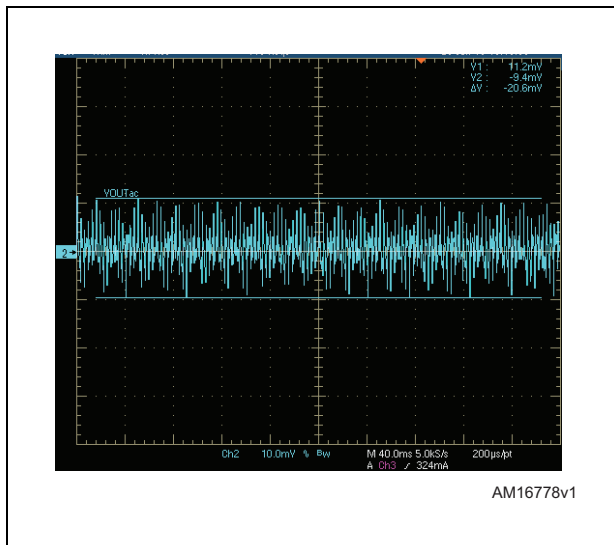
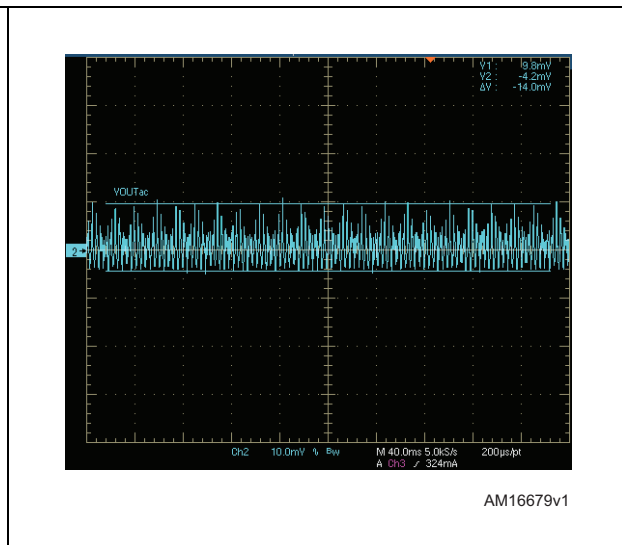


Figure 12. Output voltage ripple at 230 V<sub>AC</sub>, full load



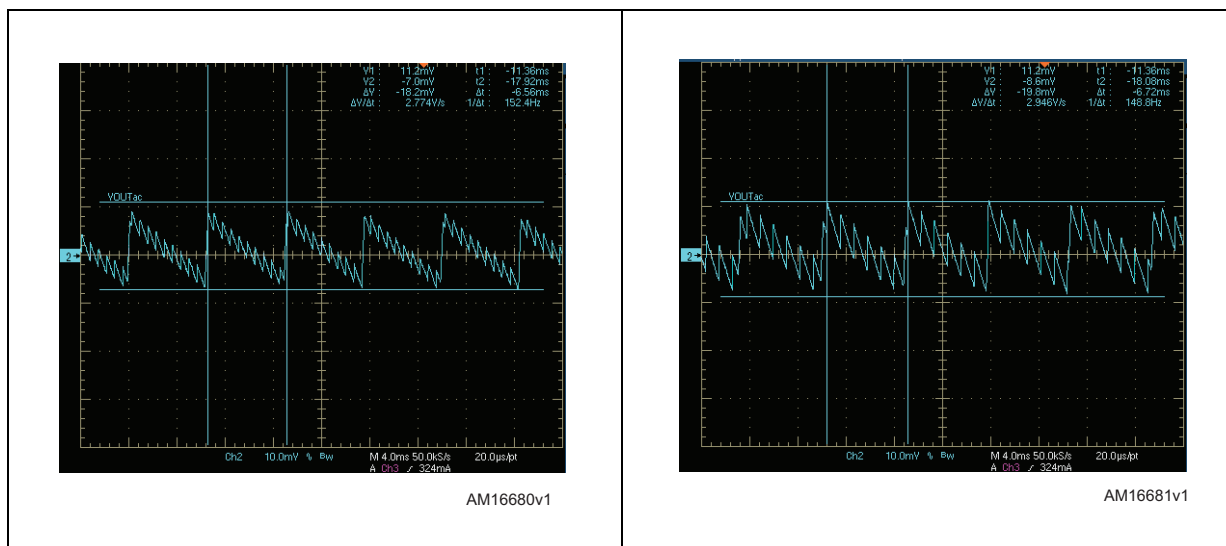
### 5.3 Burst mode and output voltage ripple

When the converter is lightly loaded, the COMP pin voltage decreases. As it reaches the shutdown threshold,  $V_{COMPL}$  (1.1 V, typical), the switching is disabled and no more energy is transferred to the secondary side. So, the output voltage decreases and the regulation loop makes the COMP pin voltage increase again. As it rises 40 mV above the  $V_{COMPL}$  threshold, the normal switching operation is resumed. This results in a controlled on/off operation (referred to as "burst mode") as long as the output power is so low that it requires a turn-on time lower than the minimum turn-on time of the VIPER06XS. This mode of operation keeps the frequency-related losses low when the load is very light or disconnected, making it easier to comply with energy-saving regulations.

The figures below show the output voltage ripple when the converter is no/lightly loaded and supplied with 115  $V_{AC}$  and with 230  $V_{AC}$  respectively.

Figure 13. Output voltage ripple at 115  $V_{AC}$ , no load

Figure 14. Output voltage ripple at 230  $V_{AC}$ , no load



### 5.4 Efficiency

The active mode efficiency is defined as the average of the efficiencies measured at 25%, 50%, 75% and 100% of maximum load, at nominal input voltage ( $V_{IN} = 115 V_{AC}$  and  $V_{IN} = 230 V_{AC}$ ).

External power supplies (the power supplies which are contained in a separate housing from the end-use devices they are powering) need to comply with the Code of Conduct, version 4 "Active Mode Efficiency" criterion, which states an active mode efficiency higher than 54.4% for a power throughput of 0.8 W.

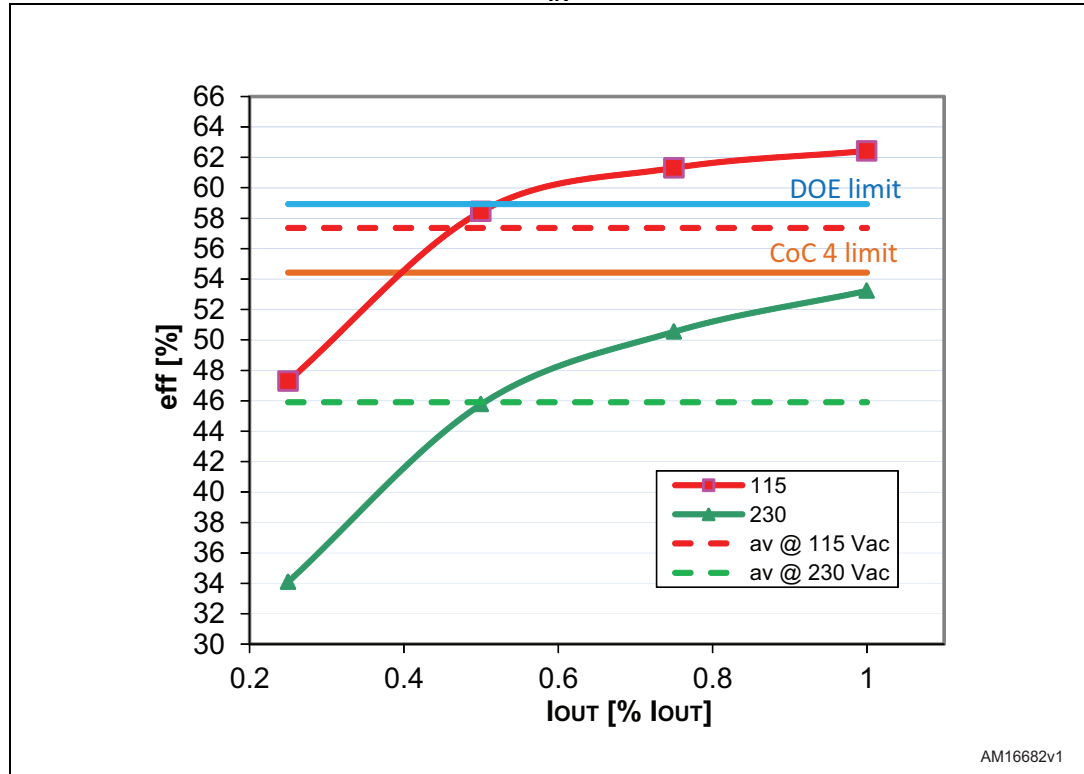
Another standard to be applied to external power supplies in the coming years is the DOE (department of energy) recommendation, whose active mode efficiency requirement for the same power throughput is 58.9%.

In [Figure 15](#) the average efficiencies of the board at 115  $V_{AC}$  (57.4%) and at 230  $V_{AC}$  (45.9%) are represented by dotted lines, and, along with the above limits, show that the STEVAL-ISA114V1 evaluation board is compliant with Code of Conduct (version 4) only at

115 V<sub>AC</sub> and is not compliant with DOE. In the same figure the efficiency at 25%, 50%, 75% and 100% of maximum load for both input voltages is also shown.

Such a low efficiency is due to the high consumption from the HV startup, which increases losses especially at high line.

Figure 15. Active mode efficiency vs. V<sub>IN</sub> and comparison with CoC4 and DOE



### 5.5 Light load performance

The input power of the converter has been measured in no load condition for different input voltages and the results are reported in [Table 3](#).

Table 3. No load input power

V <sub>IN</sub> [V <sub>AC</sub> ]	P <sub>IN</sub> [mW]
90	65
115	81
150	104
180	121
230	152
265	174

In version 4 of the Code of Conduct, the power consumption of the power supply, when it is no loaded, is also considered. The criteria to be compliant with are reported in [Table 4](#):

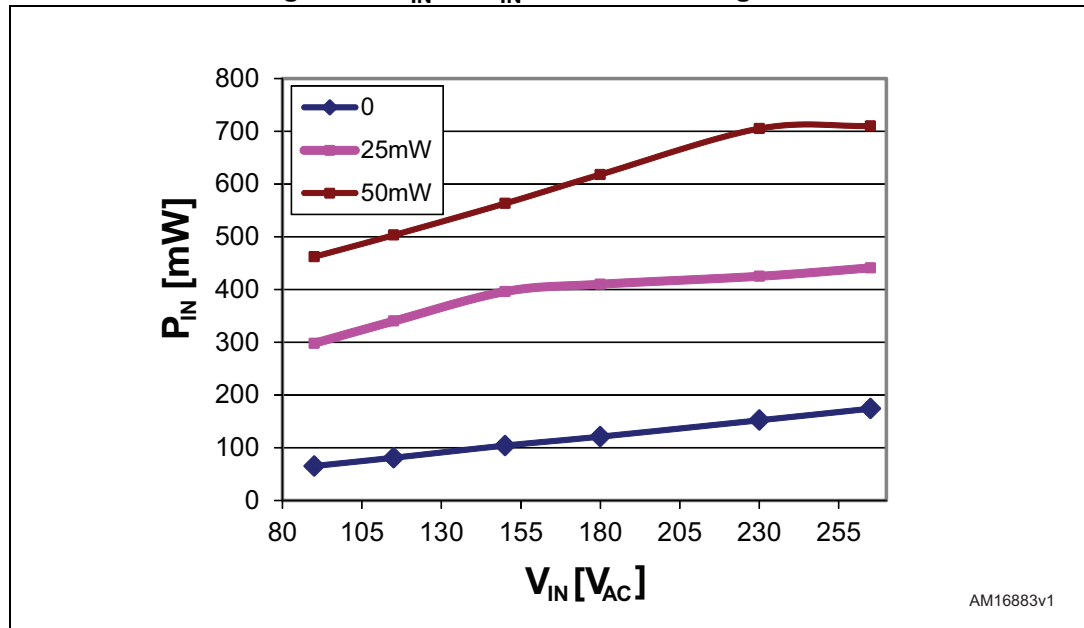
**Table 4. Energy consumption criteria for no load**

Nameplate output power ( $P_{no}$ )	Maximum power in no load for AC-DC EPS
0 to $\leq$ 50 W	< 0.3 W
> 50 W < 250 W	< 0.5 W

The power consumption of the presented board is about two times lower than the limit fixed by version 4 of the Code of Conduct. It is worth noting that often AC-DC adapter or battery charger manufacturers have very strict requirements about no load consumption and if the converter is used as an auxiliary power supply, the line filter is often the main line filter of the entire power supply which greatly increases the standby consumption.

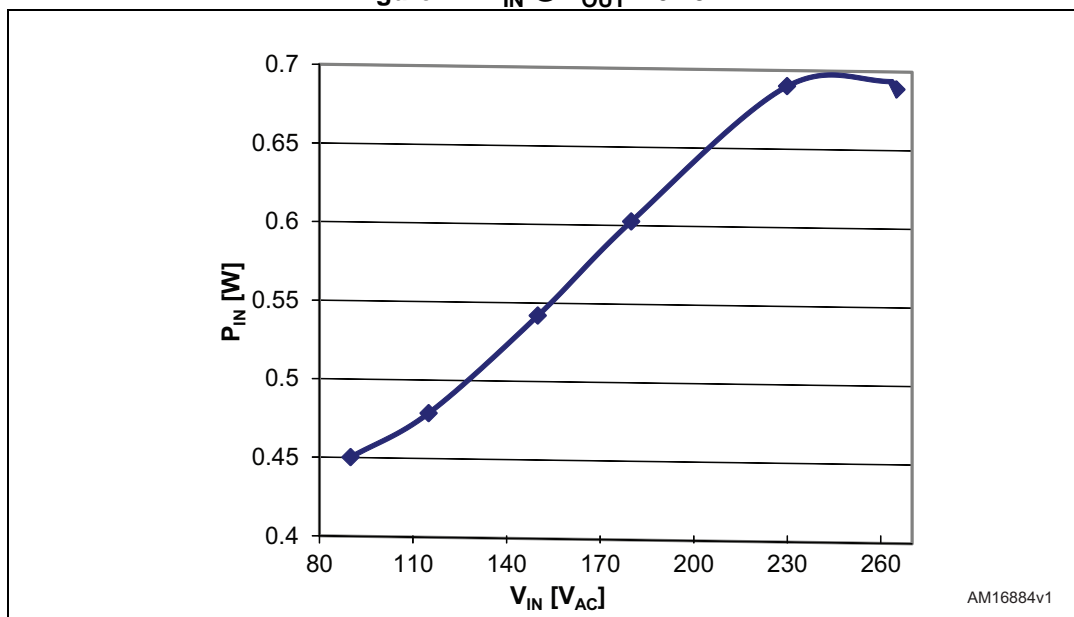
Even though version 4 of the Code of Conduct does not have other requirements regarding light load performance, in order to give a more complete overview, the consumption of the evaluation board in two other light load cases ( $P_{OUT} = 25\text{ mW}$  and  $P_{OUT} = 50\text{ mW}$ ) has also been measured. The results versus line voltage are plotted in [Figure 16](#), together with the no load measurements reported in [Table 3](#).

**Figure 16.  $P_{IN}$  vs.  $V_{IN}$  @ no load and light load**



The consumption of the evaluation board when the output is 250 mW is shown, in the entire input voltage range in [Figure 17](#).

Figure 17.  $P_{IN}$  @  $P_{OUT} = 0.25\text{ W}$



# 6 Functional check

## 6.1 Startup

The startup phase at maximum load is shown in *Figure 18* and *Figure 20* at both nominal input voltages (115 V<sub>AC</sub> and 230 V<sub>AC</sub>).

Figure 18. Startup at V<sub>IN</sub> = 115 V<sub>AC</sub>, full load

Figure 19. Startup at V<sub>IN</sub> = 115 V<sub>AC</sub>, full load, zoom

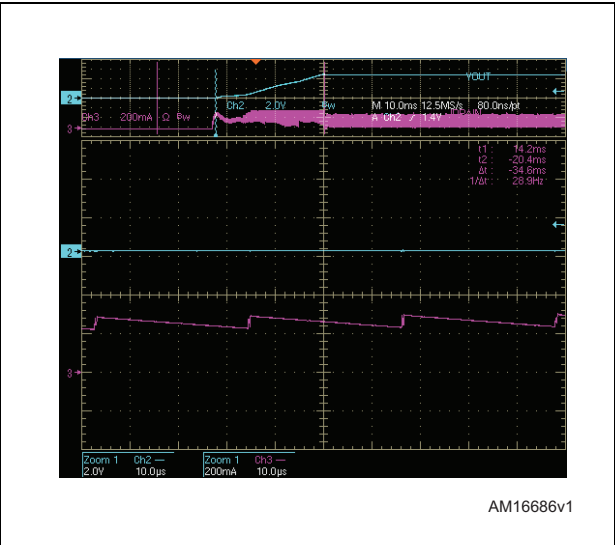
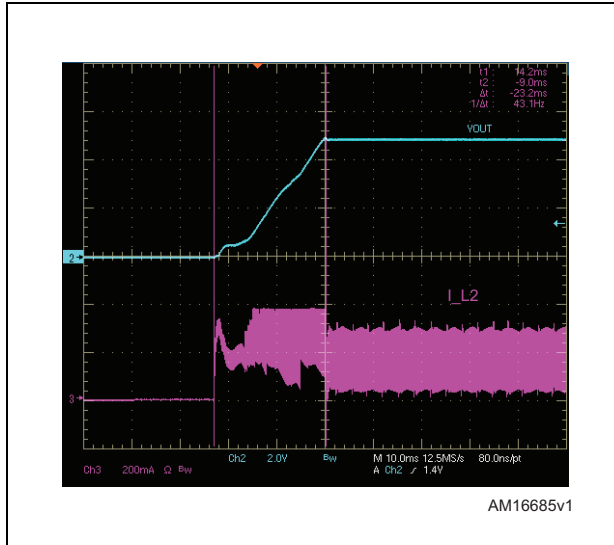
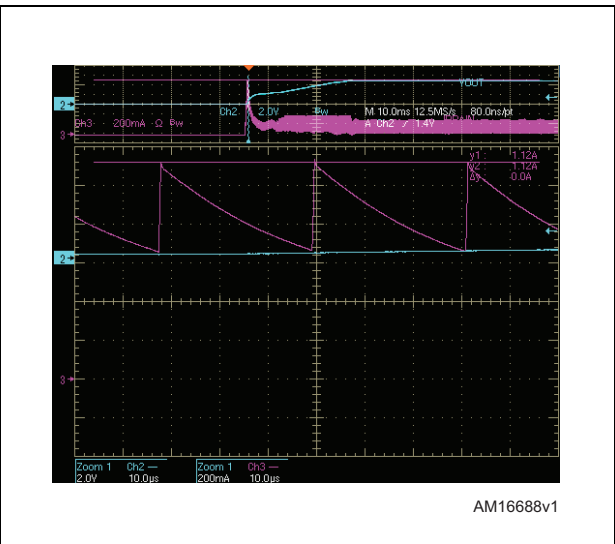
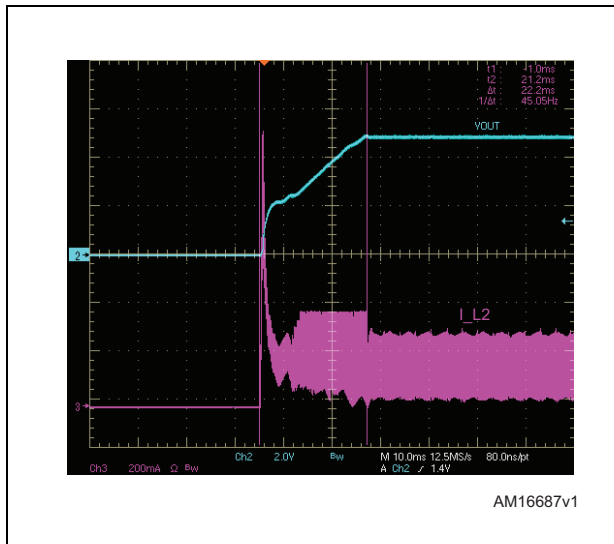


Figure 20. Startup at V<sub>IN</sub> = 230 V<sub>AC</sub>, full load

Figure 21. Startup at V<sub>IN</sub> = 230 V<sub>AC</sub>, full load, zoom



## 6.2 Overload protection

In case of overload or short-circuit (see [Figure 22](#)), the drain current reaches the  $I_{DLIM}$  value. In every cycle where this condition is met, a counter is incremented; if it is maintained continuously for the time  $t_{OVL}$  (50 msec typical, internally set) the overload protection is tripped, the power section is turned off and the converter is disabled for a  $t_{RESTART}$  time (1 sec typical). After this time has elapsed, the IC resumes switching and, if the short is still present, the protection occurs indefinitely in the same way ([Figure 23](#)). This ensures restart attempts of the converter with low repetition rate, so that it works safely with extremely low power throughput and avoids the IC overheating in case of repeated overload events. Moreover, every time the protection is tripped, the internal soft-start function is implemented, in order to reduce the stress on the secondary diode. After the short removal, the IC resumes working normally. If the short is removed during  $t_{SS}$  or  $t_{OVL}$ , before the protection tripping, the counter is decremented on a cycle-by-cycle basis down to zero and the protection is not tripped.

If the short-circuit is removed during  $t_{RESTART}$ , the IC must wait for the  $t_{RESTART}$  period to elapse before switching is resumed ([Figure 25](#)).

**Figure 22. Output short-circuit applied: OLP tripping**

**Figure 23. Output short-circuit maintained: OLP steady-state**

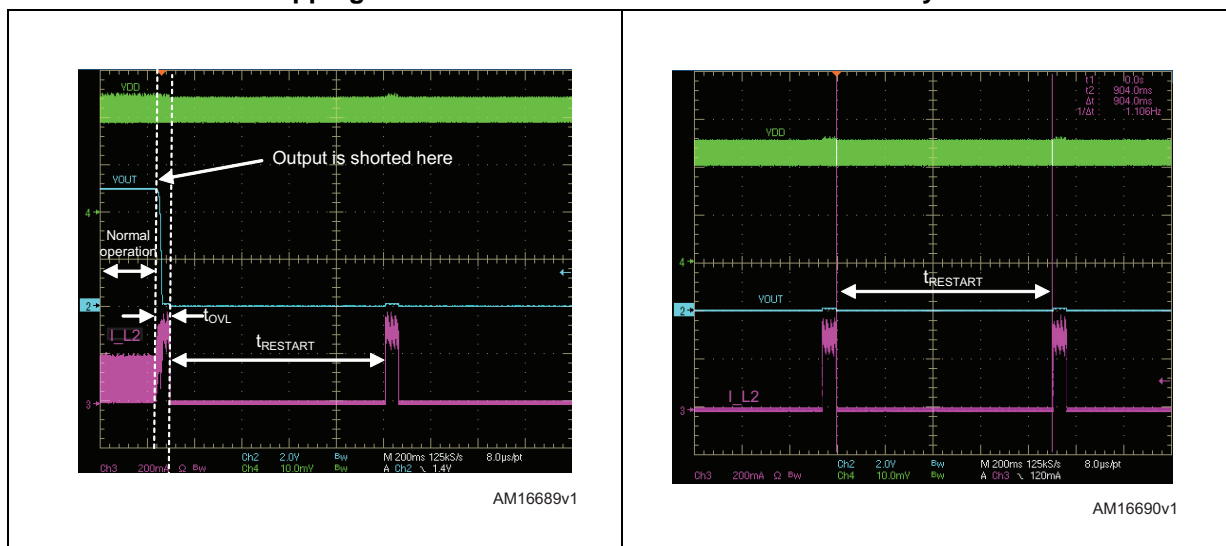


Figure 24. Output short-circuit maintained: OLP steady-state (zoom)

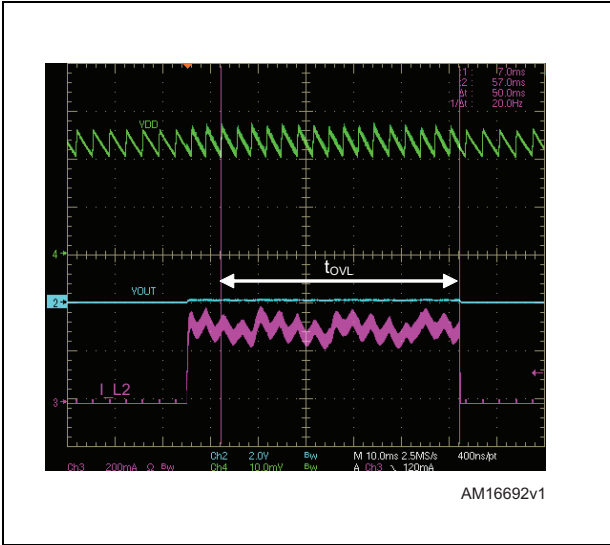
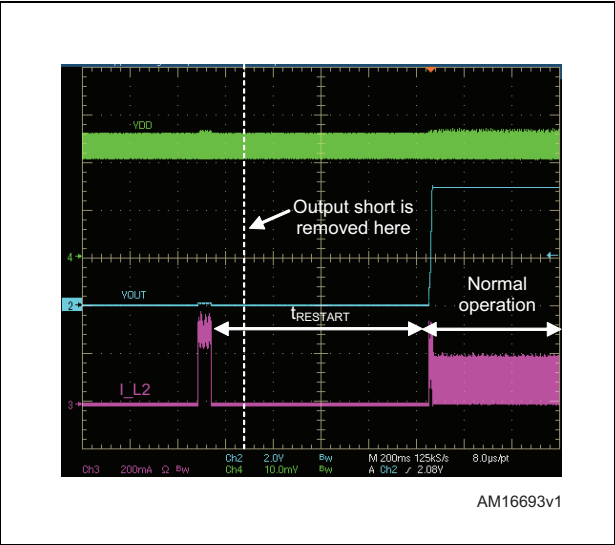


Figure 25. Output short-circuit removal and converter restart



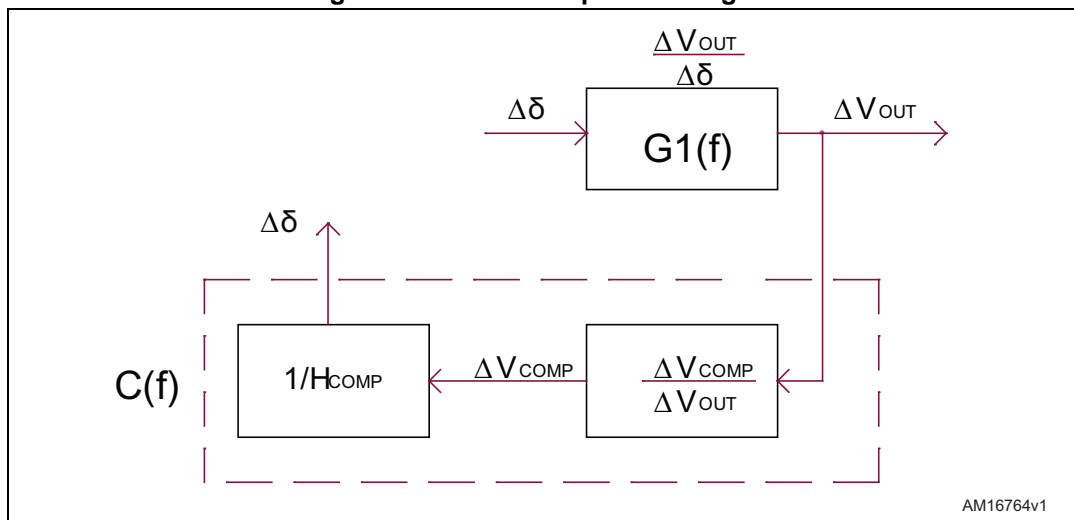


## 7 Feedback loop calculation guidelines

### 7.1 Transfer function

The set PWM modulator + power stage is indicated with  $G1(f)$ , while  $C(f)$  is the "controller", the network in charge of ensuring the stability of the system.

Figure 26. Control loop block diagram



The mathematical expression of the power plant  $G1(f)$  in DCM is the following:

#### Equation 2

$$G1(f) = \frac{\Delta V_{OUT}}{\Delta\delta} = G10 \cdot \frac{1 + \frac{j \cdot f}{f_z}}{1 + \frac{j \cdot f}{f_p}}$$

where  $f_z$  is the zero due to the ESR of the output capacitor:

#### Equation 3

$$f_z = \frac{1}{2 \cdot \pi \cdot C_{OUT} \cdot ESR}$$

and  $f_p$  is the pole due to the output load

#### Equation 4

$$f_p = \frac{1 + \beta \cdot R_{OUT}}{2 \cdot \pi \cdot C_{OUT} \cdot (ESR + R_{OUT} + ESR \cdot \beta \cdot R_{OUT})}$$

with:

#### Equation 5

$$\alpha = \frac{V_{IN} + V_\gamma}{(V_{OUT} + V_\gamma)} \cdot \frac{I_{pk}}{2}$$

**Equation 6**

$$\beta = \frac{V_{IN} + V\gamma}{(V_{OUT} + V\gamma)^2} \cdot \frac{I_{pk}}{2} \cdot \partial$$

**Equation 7**

$$G_{10} = \frac{\alpha \cdot R_{OUT}}{1 + \beta \cdot R_{OUT}} = \frac{(V_{OUT} + V\gamma) \cdot (V_{IN} + V\gamma) \cdot \frac{I_{pk}}{2} \cdot R_{OUT}}{(V_{OUT} + V\gamma)^2 \cdot (V_{IN} + V\gamma) \cdot \frac{I_{pk}}{2} \cdot R_{OUT}}$$

In the above formulas,  $C_{OUT}$  and ESR are the capacitance and the equivalent series resistance of the output capacitor respectively,  $V\gamma$  is the forward drop of the free-wheeling diode,  $R_{OUT} = V_{OUT}/I_{OUT}$  is the output load,  $I_{pk}$  is the drain peak current at full load and  $\partial = T_{on} \cdot f_{sw}$  is the duty cycle.

If just an RC series between COMP and GND is chosen as a compensation network, as shown in [Figure 2](#) (in fact  $C_c$  and CFB are not mounted), the mathematical expression of the compensator  $C(f)$  is:

**Equation 8**

$$C(s) = \frac{C_0}{H_{COMP}} \cdot \frac{\left(1 + \frac{j \cdot f}{f_{zc}}\right)}{j \cdot 2 \cdot \pi \cdot f}$$

where:

**Equation 9**

$$C_0 = \frac{L \cdot f_{sw}}{V_{IN} - V_{OUT}} \cdot \left(\frac{|-G_m|}{C7}\right) \cdot \frac{R4}{R4 + R5}$$

and:

**Equation 10**

$$f_{zc} = \frac{1}{2 \cdot \pi \cdot R3 \cdot C7}$$

they are chosen in order to ensure the stability of the overall system.

The values of  $H_{COMP} = \delta V_{COMP} / \delta I_{COMP}$  and of  $G_m$  (error amplifier transconductance) are specified in the VIPER06 datasheet.

## 7.2 Compensation procedure for a DCM buck

The first step is to choose the pole and zero of the compensator and the crossing frequency.

In this case  $C(f)$  has only a zero ( $f_{zc}$ ) and a pole at the origin, thus a possible setting is:

- $f_{zc} = k \cdot f_p$
- $f_{cross} = f_{cross\_sel} \leq f_{sw}/10$

Where  $k$  is arbitrarily chosen. A starting point could be  $k = 5$ . After setting  $f_{\text{cross\_sel}}$ ,  $G1(f_{\text{cross\_sel}})$  can be calculated from [Equation 2](#) and, since by definition it is  $|C(f_{\text{cross\_sel}}) \cdot G1(f_{\text{cross\_sel}})| = 1$ ,  $C_0$  can be calculated as follows:

#### Equation 11

$$C_0 = \frac{|j \cdot 2 \cdot \pi \cdot f_{\text{cross\_sel}}|}{\left|1 + \frac{j \cdot f_{\text{cross\_sel}}}{f_{zc}}\right|} \cdot \frac{H_{\text{COMP}}}{|G1(f_{\text{cross\_sel}})|}$$

At this point the Bode diagram of  $G1(f) \cdot C(f)$  can be plotted, in order to check the phase margin for the stability.

If the margin is not high enough, another choice should be made for  $k$  and  $f_{\text{cross\_sel}}$ , and the procedure is repeated.

When the stability is ensured, the next step is to find the values of the schematic components, which can be calculated as follows:

from [Equation 9](#)

#### Equation 12

$$C7 = \frac{L \cdot f_{\text{sw}}}{V_{\text{IN}} - V_{\text{OUT}}} \cdot \left(\frac{|-Gm|}{C_0}\right) \cdot \frac{R4}{R4 + R5}$$

and from [Equation 10](#)

#### Equation 13

$$R3 = \frac{1}{2 \cdot \pi \cdot f_{zc} \cdot C7}$$

The quantities found in [Equation 12](#) and [Equation 13](#) are suggested values. Commercial values are chosen, let us call them  $C7_{\text{act}}$ ,  $R7_{\text{act}}$ , resulting into  $f_{zc\_act}$ .

#### Equation 14

$$f_{zc\_act} = \frac{1}{2 \cdot \pi \cdot R3_{\text{act}} \cdot C7_{\text{act}}}$$

$C_0$  value is also recalculated from [Equation 9](#)

#### Equation 15

$$C_{0\_act} = \frac{L \cdot f_{\text{sw}}}{V_{\text{IN}} - V_{\text{OUT}}} \cdot \left(\frac{|-Gm|}{C7_{\text{act}}}\right) \cdot \frac{R4_{\text{act}}}{R4_{\text{act}} + R5(4)_{\text{act}}}$$

and the compensator becomes:

## Equation 16

$$C_{\text{act}}(f) = \frac{C_{0\_\text{act}}}{H_{\text{COMP}}} \cdot \frac{\left(1 + \frac{f}{f_{z_{c\_act}}}\right)}{j \cdot 2 \cdot \pi \cdot f}$$

At this point the Bode diagram of  $G1(f) \cdot C_{\text{act}}(f)$  should be plotted, and check if the phase margin for the stability is maintained.

## 8 Thermal measurements

A thermal analysis of the evaluation board in full load condition at  $T_{\text{AMB}} = 25\text{ }^{\circ}\text{C}$  has been performed using an IR camera. The results are shown in the following figures.

**Figure 27. Thermal measurement @  $V_{\text{IN}} = 80\text{ V}_{\text{AC}}$ , full load**

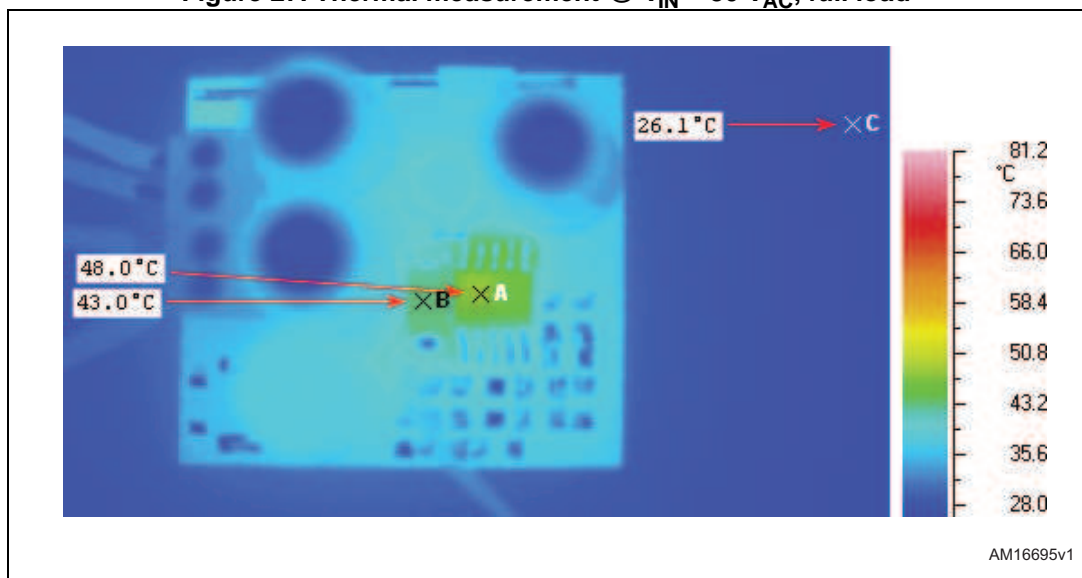


Figure 28. Thermal measurement @  $V_{IN} = 115 V_{AC}$ , full load

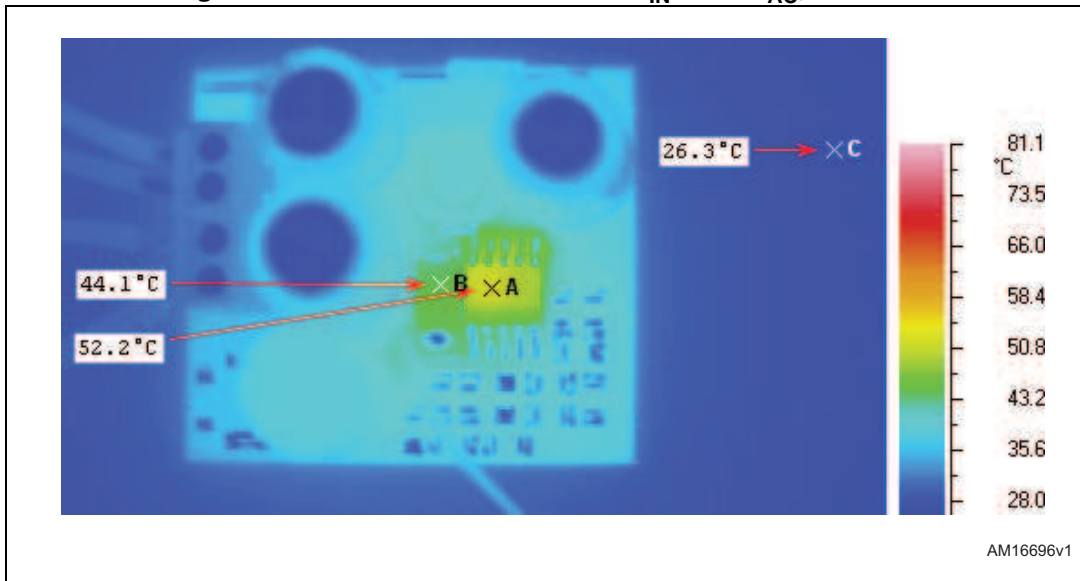


Figure 29. Thermal measurement @  $V_{IN} = 230 V_{AC}$ , full load

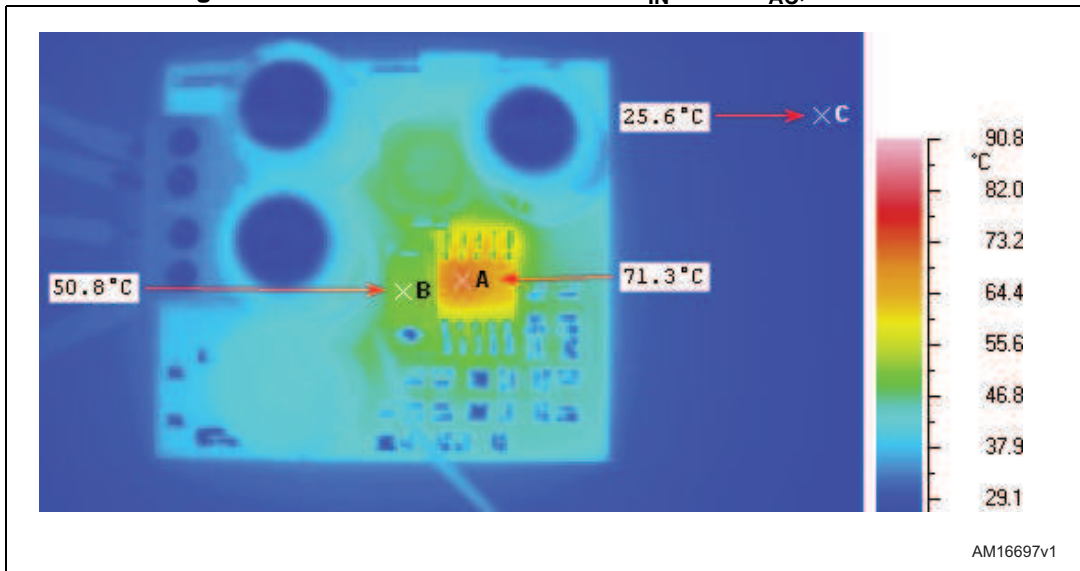
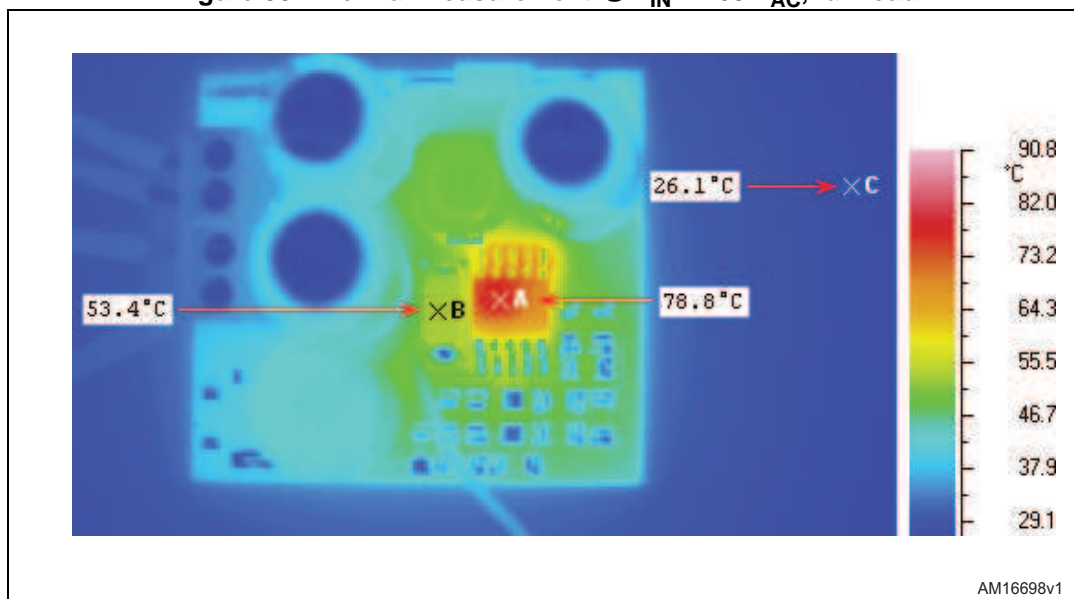


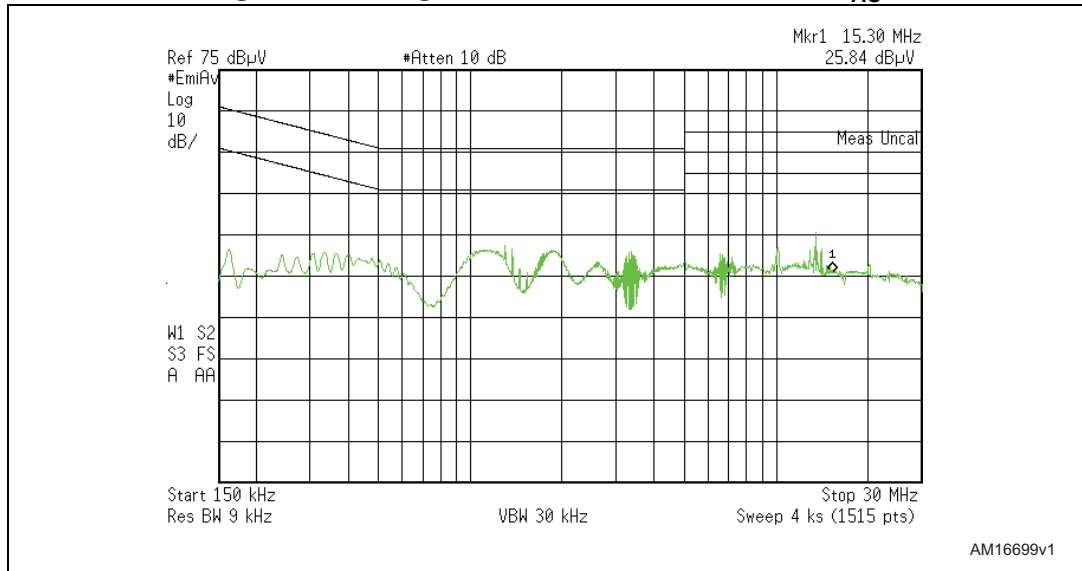
Figure 30. Thermal measurement @  $V_{IN} = 265 V_{AC}$ , full load



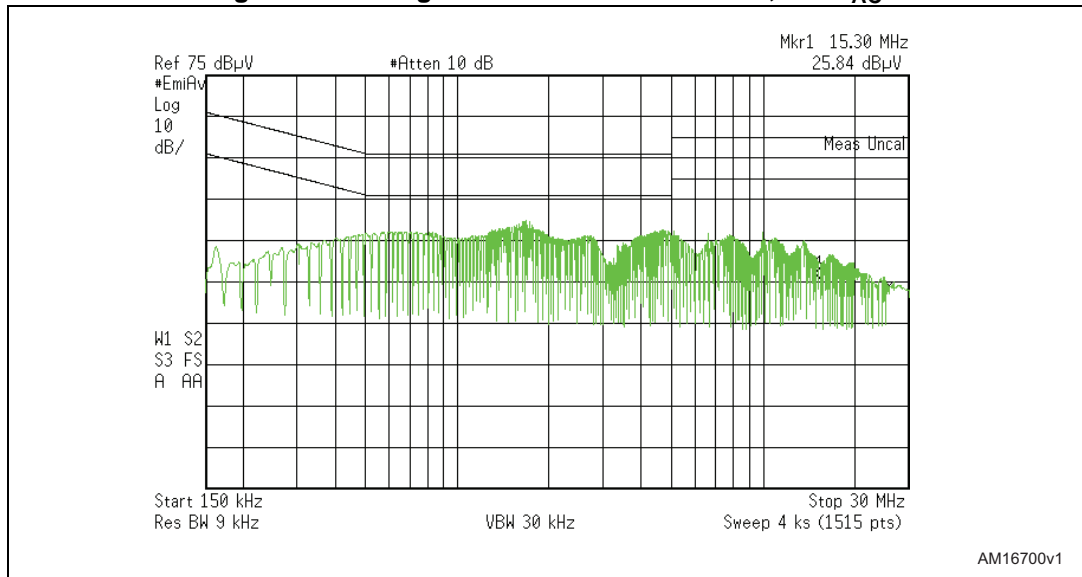
## 9 EMI measurements

A pre-compliant test to EN55022 (Class B) European normative has been performed using an EMC analyzer and an LISN. The average EMC measurements at 115 V<sub>AC</sub>/full load and 230 V<sub>AC</sub>/full load have been performed and the results are shown in [Figure 31](#) and [Figure 32](#).

**Figure 31. Average measurement at full load, 115 V<sub>AC</sub>**



**Figure 32. Average measurement at full load, 230 V<sub>AC</sub>**

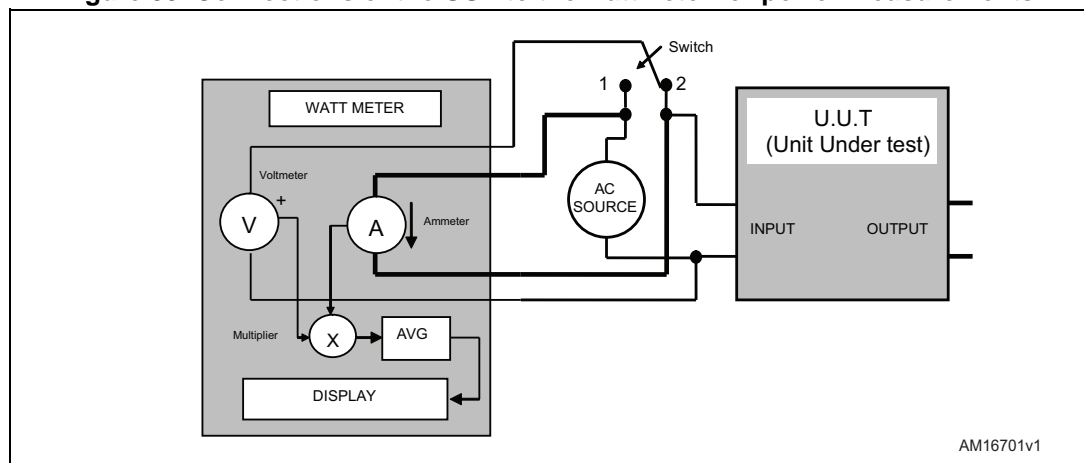


## Appendix A Test equipment and measurement of efficiency and light load performance

The converter input power has been measured using a wattmeter. The wattmeter measures simultaneously the converter input current (using its internal ammeter) and voltage (using its internal voltmeter). The wattmeter is a digital instrument so it samples the current and voltage and converts them to digital forms. The digital samples are then multiplied giving the instantaneous measured power. The sampling frequency is in the range of 20 kHz (or higher depending on the instrument used). The display provides the average measured power, averaging the instantaneous measured power in a short period of time (1 sec typ.).

Figure 33 shows how the wattmeter is connected to the UUT (unit under test) and to the AC source and the wattmeter internal block diagram.

Figure 33. Connections of the UUT to the wattmeter for power measurements



An electronic load has been connected to the output of the power converter (UUT), allowing the converter load current to be set and measured, while the output voltage has been measured by a voltmeter. The output power is the product between load current and output voltage. The ratio between the output power, calculated as previously stated, and the input power, measured by the wattmeter, is the converter's efficiency, which has been measured in different input/output conditions.

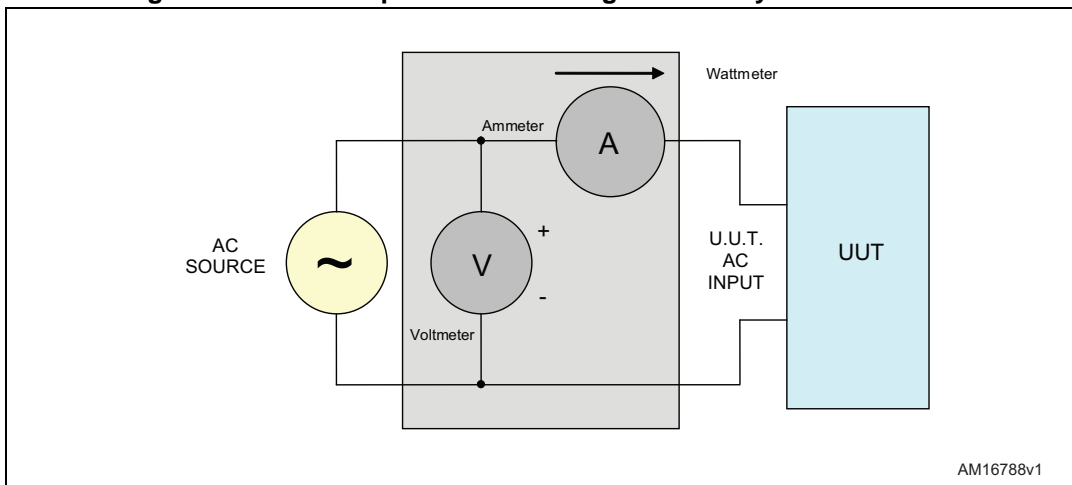
### A.1 Measuring input power

With reference to Figure 33, the UUT input current causes a voltage drop across the ammeter's internal shunt resistance (the ammeter is not ideal as it has an internal resistance higher than zero) and across the cables connecting the wattmeter to the UUT.

If the switch of Figure 33 is in position 1 (see also the simplified scheme of Figure 34), this voltage drop causes an input measured voltage higher than the input voltage at the UUT input that, of course, affects the measured power. The voltage drop is generally negligible if the UUT input current is low (for example when we are measuring the input power of UUT in light load condition).

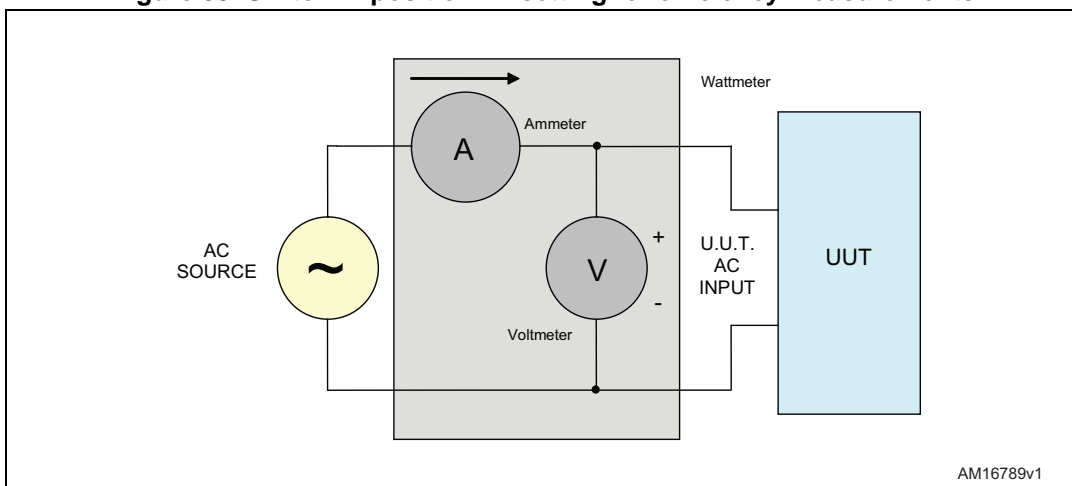


Figure 34. Switch in position 1 - setting for standby measurements



In the case of high UUT input current (i.e. for measurements in heavy load conditions), the voltage drop can be relevant compared to the UUT real input voltage. If this is the case, the switch in [Figure 33](#) can be changed to position 2 (see simplified scheme of [Figure 35](#)) where the UUT input voltage is measured directly at the UUT input terminal and the input current does not affect the measured input voltage.

Figure 35. Switch in position 2 - setting for efficiency measurements



On the other hand, the position of [Figure 35](#) may introduce a relevant error during light load measurements, when the UUT input current is low and the leakage current inside the voltmeter itself (which is not an ideal instrument and doesn't have infinite input resistance) is not negligible. This is the reason why it is recommended the setting of [Figure 34](#) to be used for light load measurements and [Figure 35](#) for heavy load measurements.

If it is not clear which measurement scheme has the lesser effect on the result, try with both and register the lower input power value.

As noted in IEC 62301, instantaneous measurements are appropriate when power readings are stable. The UUT is operated at 100% of nameplate output current output for at least 30 minutes (warm-up period) immediately prior to conducting efficiency measurements.

After this warm-up period, the AC input power is monitored for a period of 5 minutes to assess the stability of the UUT. If the power level does not drift by more than 5% from the maximum value observed, the UUT can be considered stable and the measurements can be recorded at the end of the 5-minute period. If AC input power is not stable over a 5-minute period, the average power or accumulated energy is measured overtime for both AC input and DC output.

Some wattmeter models allow integration of the measured input power in a time range and then measure the energy absorbed by the UUT during the integration time. The average input power is calculated dividing by the integration time itself.

## 10 References

- [1] Code of Conduct on energy efficiency of external power supplies, version 4
- [2] VIPER06 datasheet

## Revision history

**Table 5. Document revision history**

Date	Revision	Changes
01-Aug-2013	1	Initial release.
15-Dec-2014	2	Updated: <i>Equation 8, Equation 11 and Equation 16.</i>
09-Sep-2016	3	Updated: <a href="#">Figure 1: STEVAL-ISA114V1 evaluation board</a> on the cover page.

**IMPORTANT NOTICE – PLEASE READ CAREFULLY**

STMicroelectronics NV and its subsidiaries ("ST") reserve the right to make changes, corrections, enhancements, modifications, and improvements to ST products and/or to this document at any time without notice. Purchasers should obtain the latest relevant information on ST products before placing orders. ST products are sold pursuant to ST's terms and conditions of sale in place at the time of order acknowledgement.

Purchasers are solely responsible for the choice, selection, and use of ST products and ST assumes no liability for application assistance or the design of Purchasers' products.

No license, express or implied, to any intellectual property right is granted by ST herein.

Resale of ST products with provisions different from the information set forth herein shall void any warranty granted by ST for such product.

ST and the ST logo are trademarks of ST. All other product or service names are the property of their respective owners.

Information in this document supersedes and replaces information previously supplied in any prior versions of this document.

© 2016 STMicroelectronics – All rights reserved