

Social Distancing Detection using Bluetooth® Low Energy

Introduction

This social distancing application help users maintain safe distances and minimize the risk of contracting infectious diseases such as COVID-19 by generating an alert when two people come within a minimum set distance of each other, usually 2 meters or less. The application involves wireless Bluetooth® Low Energy (BLE) communication between wearable nodes based on the BlueNRG-1 or BlueNRG-2 systems on chip.

The nodes simultaneously advertise their presence and scan for the presence of other similar beacons in range, while deploying LowPower Modes during periods of inactivity to conserve battery power.

Advertising is performed on three channels and no connection or response packet are required between the devices during advertising and scanning activities (ADV_NONCONN_IND).

Figure 1. Distance zones

1. Alert zone = 2 meters
2. Pre-alert zone = 3 meters
3. Safe zone = more than 3 meters

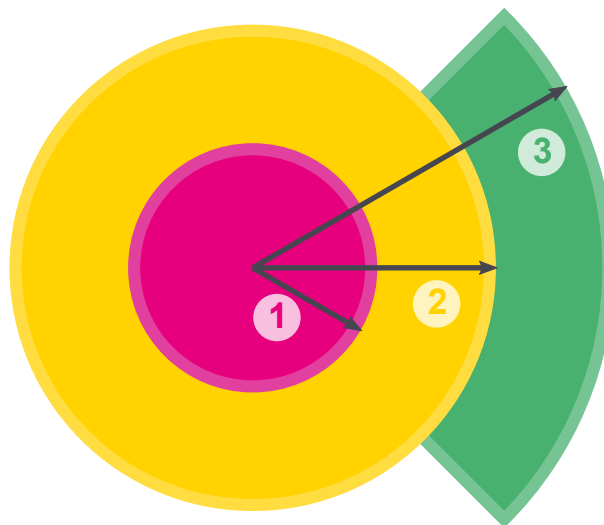

RELATED LINKS

Visit the [Bluetooth website](#) for more information on Bluetooth specification version 4.0 [vol 0] and V5.0

1 iBeacon standard

We chose the iBeacon advertising format for this application because it is relatively straightforward, it offers reliable performance, and works on both iOS and Android operating systems.

The standard uses a 30-byte packet length comprised of:

- 3-byte header: (AD length, AD type and flags)
- 27-byte payload: (AD length, AD type, Company ID, iBeacon type, iBeacon length, UUID, major number, minor number and transmit output power) parameters as shown in the figure below.

Figure 2. iBeacon advertising packet

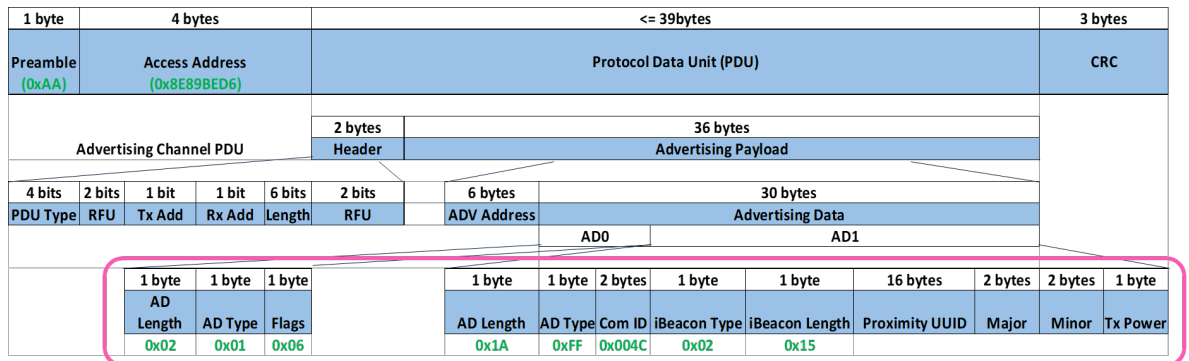

30 bytes Advertising data

Other beacon standards like Eddystone can also be used for transmitting data to other nodes, but these implement different packet protocols.

RELATED LINKS

[See the Getting Started with iBeacon document for more information](#)

2 Overview of proximity detection

The proximity detection algorithm handles simultaneous advertising and scanning.

Figure 3. Proximity detection based on RSSI

1. Advertising:
 - Generate Beacon (known Tx Power in beacon)
2. Scanning:
 - Beacon detected
 - Check RSSI
 - Store device ID and time in Flash



RELATED LINKS

Visit the following location for more information on how to calculate distances based on RSSI signal strength

2.1 System startup and initialization

After power on, the system firmware performs the following sequence:

1. initializes the BLE stack
2. initializes the accelerometer:
 - calculates its gain and offset values
3. configures general discoverable mode operation:
 - `AD_TYPE` set to Non connectable undirected advertising mode (`ADV_NONCONN_IND`)
 - no connection between devices, only advertising and passive scanning
4. sets the scan window and scan interval parameter values:
 - the defaults can be changed according to user requirements

Table 1. Default advertising and scanning intervals

Parameters	Normal Mode	High Probability Detection Mode	Comments
ADV_INTERVAL_MIN	N = 240 (150ms)	N = 160 (100ms)	Time = N * 0.625ms
ADV_INTERVAL_MAX	N = 240 (150ms)	N = 160 (100ms)	
SCAN_INTERVAL	N = 400 (250ms)	N = 240 (150ms)	
SCAN_WINDOW	N = 320 (200ms)	N = 160 (100ms)	

2.2 System operation

As soon as a device detects a beacon, the `hci_le_advertising_report_event` call back function is invoked.

It provides the information that Bluetooth device has received some information during a passive scan.

The Controller maintains the queue of these advertising packets and provides the information from multiple devices in one LE Advertising Report event.

The function derives the Tx power and RSSI value and stores the samples individually in the `sBeacon` data structure, along with the current time stamp and node index value.

Currently in this structure storage of few samples is done (for example 20, this is configurable in software) from same device. If no beacons are received from the same address over a certain period of time, the data is flushed. If the device is continuously receiving samples from the same device then samples will be stored in round robin format.

The configurable `MAX_NODE_COUNT` parameter sets the maximum number of different devices that samples will be stored for (default is 20).

The weighted mean and average filter are applied to remove the variations in the RSSI signal due to external factors such as absorption, interference and diffraction.

The distance from a detected beacon is determined from the following equation:

$$\text{Distance} = 10^{\frac{\text{TxPower}-\text{RSSI}}{10*N}}$$

where:

- TxPower = transmit power configured in the beacon packet and defined in the application
- RSSI = filtered Received Signal Strength Indicator
- N = Environmental factor; constant normally between 2 and 4 (4 is used in application)

The application signals when the calculated Distance value falls below a set threshold (e.g., 2 meters) with a flashing LED or buzzer alert.

Figure 4. Flowchart of algorithm logic

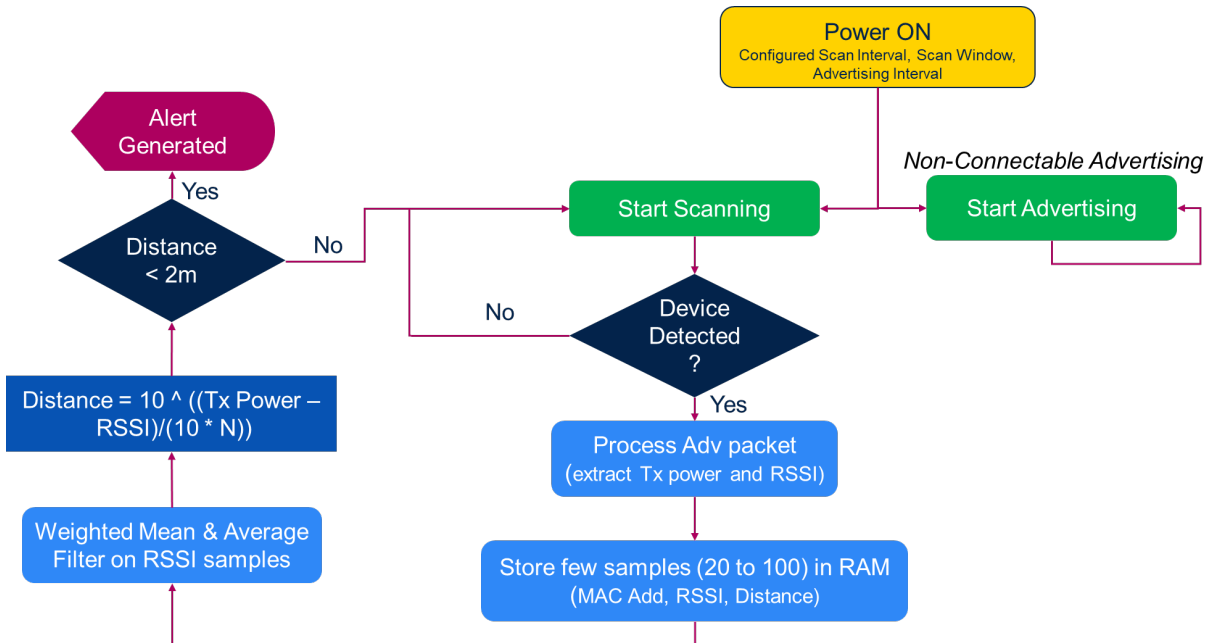

The beacon does not advertise continuously, but according to defined minimum and maximum advertising intervals (i.e., 150 ms in normal mode).

Note: Adjusting the advertising interval and scan window parameters can impact battery life significantly.

The interval must be an integer multiple of 0.625 ms ($\text{Time} = N * 0.625 \text{ ms}$) from 20 ms to 10.24 s. But for non-connectable undirected event type (`ADV_NONCONN_IND`), the minimum advertising interval can be 20 ms. There is also a random delay of 0 to 10 ms in each advertising packet, which is generated by the Link Layer.

Figure 5. Advertising intervals and scan windows

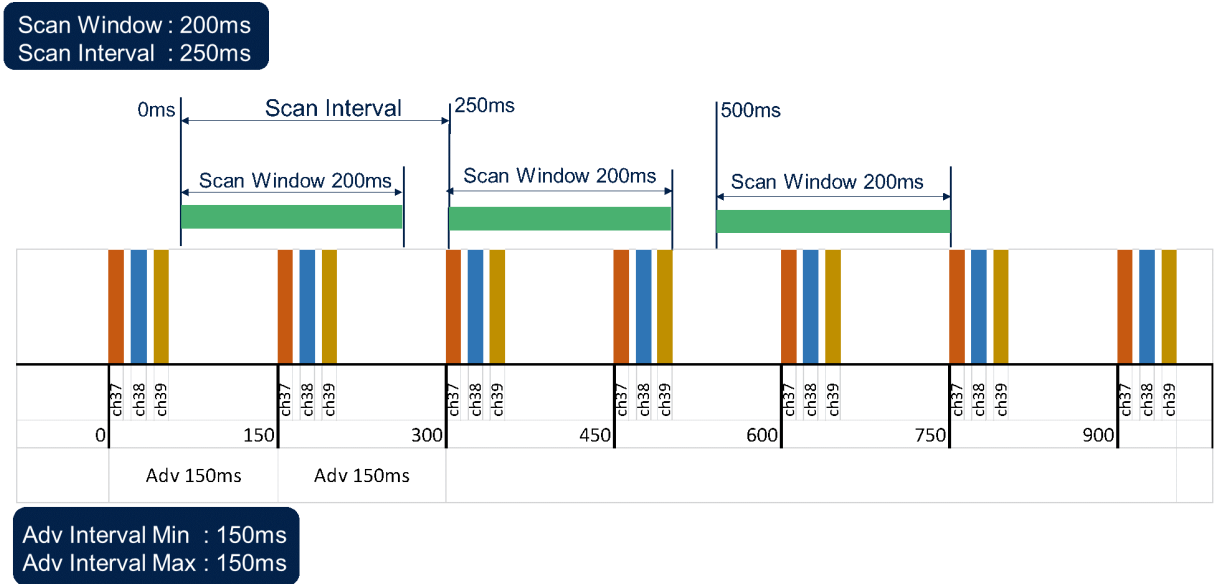

2.3 RSSI filtering techniques

RSSI filtering is required to limit the potentially high variation in received signal strength due to multi-path reflections and environmental factors.

2.3.1 Weighted mean filter

Weighted mean filter is also known as feedback filtering because previous RSSI values contribute to the calculation of the filtered output.

Suppose A and B are measured values for signal C. Signal C is the estimated value after passing A and B through filters. As the noise measured in A or B might be high or low frequency, the low-pass filter Alpha is complemented by the high-pass filter $1 - \text{Alpha}$, where Alpha is a value between 0 and 1.

Figure 6. Advertising and scanning

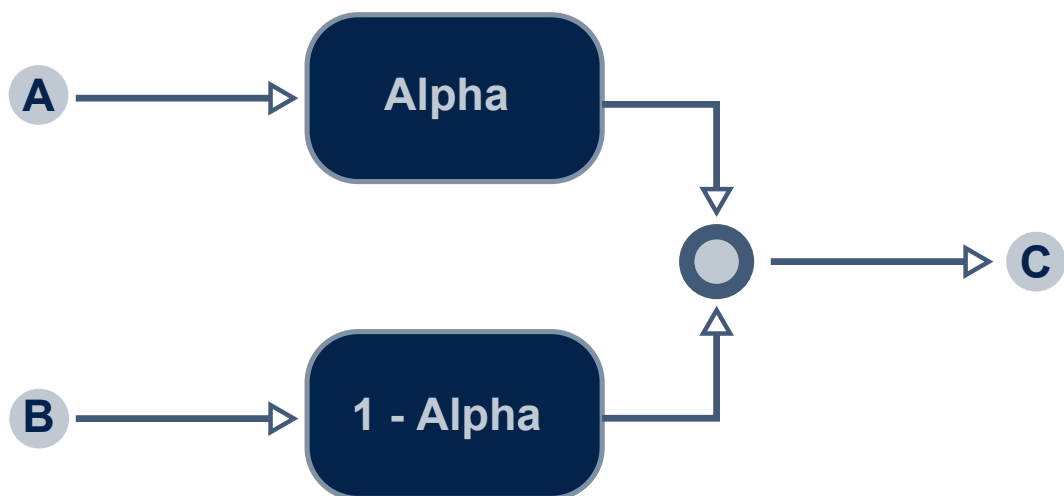

As the source of A and B derive from the same signal, their noise components should be similar in nature, and a weighted mean between two measured values can act as a basic complimentary filter. Experiments on different values of alpha showed a minimal variation for a value of alpha between 0.6 to 0.7.

For an alpha of 0.6, 60% of the weighting is applied to the previous RSSI measurement and 40% to the current measurement. The current value of RSSI is then replaced with the filtered value and saved in RAM.

```

/***** Weighted Mean/Feedback Filtering *****/
int8_t Weighted_Mean(int8_t aPrevious_RSSI,int8_t aCurrent_RSSI)
{
  int8_t filter_rssi = 0;
  filter_rssi = (int8_t)((1 - ALPHA) * aCurrent_RSSI) + (ALPHA * aPrevious_RSSI);
  return filter_rssi;
}
  
```

2.3.2 Average filter

Average filtering, or moving average filtering, further reduces noise by taking the average of a series of complementary or weighted mean filter outputs saved in RAM.

```

/***** Average Filter *****/
int16_t Average_Filter(uint8_t aNodeIndex,uint8_t aSample_count)
{
  int16_t Total_RSSI=0;
  for(uint8_t count=0;count <= aSample_count ; count++)
  {
    Total_RSSI = Total_RSSI + sBeacon[aNodeIndex].rssi_value[count] ;
  }
  return (Total_RSSI / (aSample_count + 1)) ;
}
  
```

2.4 Accounting for tilt angles

The results from testing indicate that the difference in tilt angle between a beacon and the detecting device has a greater impact on RSSI and distance measurement accuracy than their relative positions around each other.

The firmware therefore includes a lookup table to account for different tilt angles and ensure the best possible RSSI band capture for a node at the nominal safe distance of 2 meters.

The Relative tilt vs RSSI lookup table contains values derived from testing and can be refined by the user with further information regarding relative angles at similar distances. Conditional statements are derived from the preferred bands for RSSI sampling in the danger zone, where the distance between nodes is less than 2 meters.

Figure 7. RSSI signal strength over distance

1. Alert zone = 2 meters
2. Pre-alert zone = 3 meters
3. Safe zone = more than 3 meters

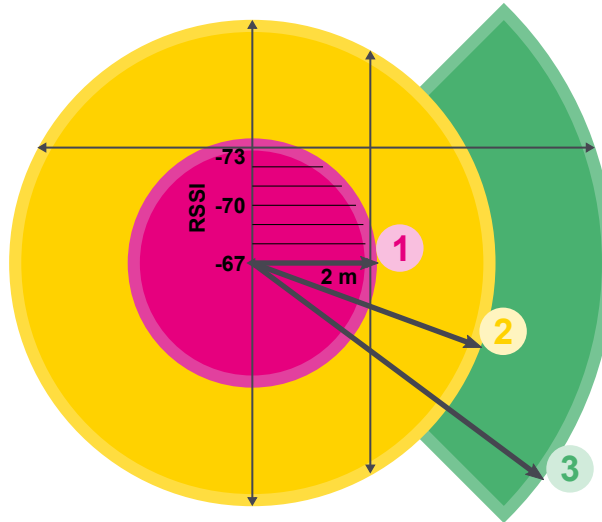

```
Cconst int table[ ][7] =
  {{Tiltx1, Tilty1, Tiltz1, Theta, RSSI Min, RSSI Max, RSSI Avg},
  {Tiltx1, Tilty1, Tiltz1, Theta + 90, RSSI Min, RSSI Max, RSSI Avg},
  {Tiltx1, Tilty1, Tiltz1, Theta + 180, RSSI Min, RSSI Max, RSSI Avg},
  {Tiltx1, Tilty1, Tiltz1, Theta + 270, RSSI Min, RSSI Max, RSSI Avg},

  {Tiltx1 + 90, Tilty1, Tiltz1 + 90, Theta, RSSI Min, RSSI Max, RSSI Avg},
  {Tiltx1 + 90, Tilty1, Tiltz1 + 90, Theta + 90, RSSI Min, RSSI Max, RSSI Avg},
  {Tiltx1 + 90, Tilty1, Tiltz1 + 90, Theta + 180, RSSI Min, RSSI Max, RSSI Avg},
  {Tiltx1 + 90, Tilty1, Tiltz1 + 90, Theta + 270, RSSI Min, RSSI Max, RSSI Avg},

  {Tiltx1, Tilty1 + 90, Tiltz1 + 90, Theta, RSSI Min, RSSI Max, RSSI Avg},
  {Tiltx1, Tilty1 + 90, Tiltz1 + 90, Theta + 90, RSSI Min, RSSI Max, RSSI Avg},
  {Tiltx1, Tilty1 + 90, Tiltz1 + 90, Theta + 180, RSSI Min, RSSI Max, RSSI Avg},
  {Tiltx1, Tilty1 + 90, Tiltz1 + 90, Theta + 270, RSSI Min, RSSI Max, RSSI Avg},
  };
```

Table 2. RSSI lookup table

Relative tilt X (deg)	Relative tilt Y (deg)	Relative tilt Z (deg)	Min RSSI (dBm)	Comments
0	0	0	-67	Min RSSI band inside 2m varies from -67 to -73
<20°	20 < Y < 90	20 < Z < 90	-69	
<20	< 20	< 20	-70	
20 < X < 90	< 20	20 < Z < 90	-73	
Multiple combinations to be added				

RELATED LINKS

- [See the paper for Compensation of the Antenna Polarization Misalignment in the RSSI Estimation](#)
- [4 Test results on page 11](#)

3 Device operating modes

3.1 High probability detection

The initial device state is the active Normal Mode with a 150 ms advertising interval, 250 ms scanning interval, and 200 ms scanning window.

The device enters High Detection Mode if it detects more beacons than a configurable threshold value (default is 5) within 500 ms. In this mode, the advertising interval is raised to 100 ms, the scanning interval to 150 ms, and scanning window to 100 ms.

Figure 8. High detection scanning and advertising intervals

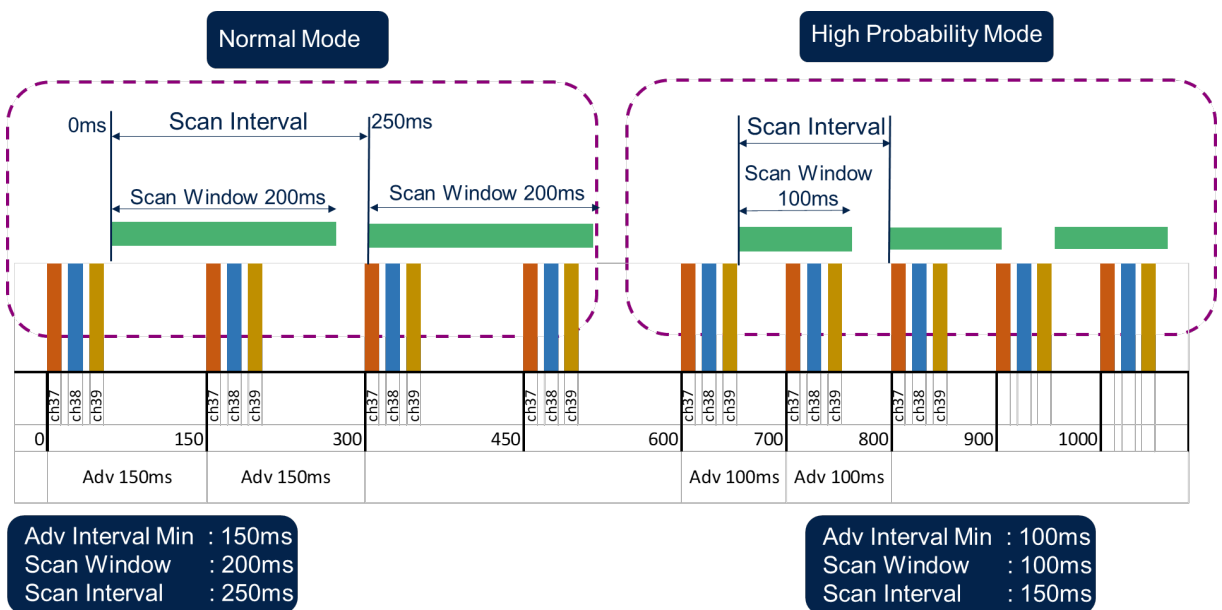

3.2 Low power operation

Low Power Mode allows the device to save power and increase battery life when no beacon is detected or when the device remains stationary for a certain amount of time.

3.2.1 No beacon detected

If the device does not detect any beacons in range for `MAX_BEACON_LOSS_COUNT` (2 s) seconds, it enters low power sleep state for `DEVICE_SLEEP_DURATION` (1 s) second. The Observation Procedure is terminated and the device does not transmit any advertising data in connectionless packets.

The device is then placed in Non-discoverable Mode so it cannot enter the `INQUIRY_SCAN` state, after which the device enters Sleep Mode. Before putting the radio in sleep mode, the device checks that there is no ongoing transmission on the UART terminal.

The device can be woken from its sleep state either by a virtual timer or GPIO event. The virtual timer power management policy keeps the virtual timer running while the device is in sleep mode. After 1 second, the device wakes up and switches to Normal Mode, with the resumption of advertising and scanning activities.

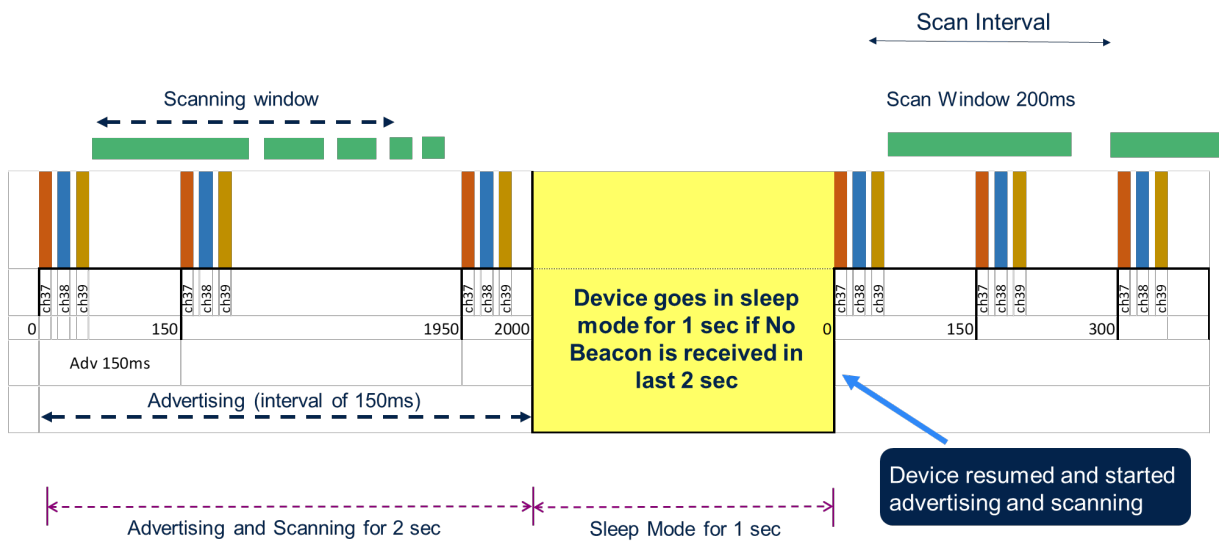
Figure 9. Low Power Mode activation

3.2.2 No movement detected from accelerometer

If no movement is detected by the accelerometer for `DEVICE_HALT_TIME` (60 s), it is assumed that user has removed the band and the device is put to sleep. If the device is tilted more than a threshold value, it is woken up and placed in Normal Mode by the GPIO interrupt (GPIO_Pin_13) connected to the accelerometer interrupt line. The following table shows the accelerometer register configuration to generate the wake-up event using the high-pass digital filter.

Table 3. Accelerometer register configuration for wake-up event

Register Name	Address	Value	Comments
CTRL1_XL	0x10	0x60	Turn on the accelerometer (ODR_XL = 416 Hz, FS_XL = ±2 g)
TAP_CFG	0x58	0x10	Apply high-pass digital filter; latch mode disabled
WAKE_UP_DUR	0x5C	0x00	No duration
WAKE_UP_THS	0x5B	0x02	Set wake-up threshold
MD1_CFG	0x5E	0x20	Wake-up interrupt driven to INT1 pin

Figure 10. No movement detection logic

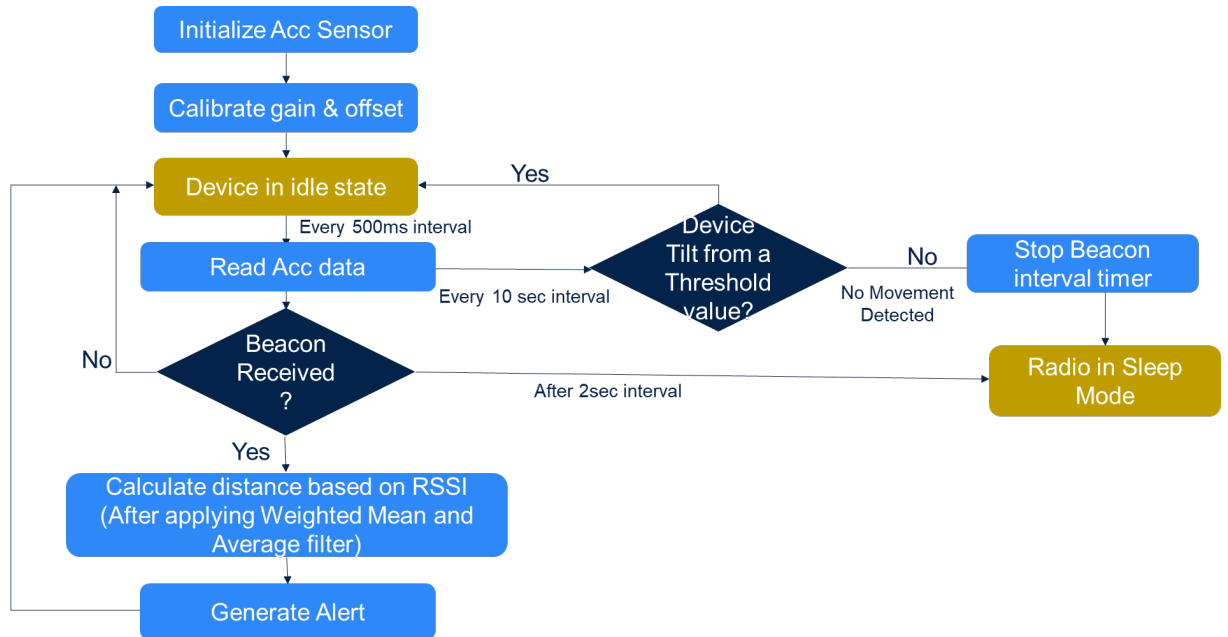

4 Test results

4.1 Impact of node rotation along an axis on RSSI

This test observed how tilting the antenna affected RSSI on a receiver, Node B, at a distance of 2 meters from the transmitter Node A.

Using the 3 accelerometer axes for reference, the device is rotated along the Y-axis to tilt the Z-X plane, and along the X-axis to tilt the Z-Y plane. The mean value of multiple RSSI measurements are taken for a series of axis rotations and corresponding tilt angles, and the derived distance is compared with the actual distance to determine the magnitude of error.

Figure 11. Node rotation along an axis

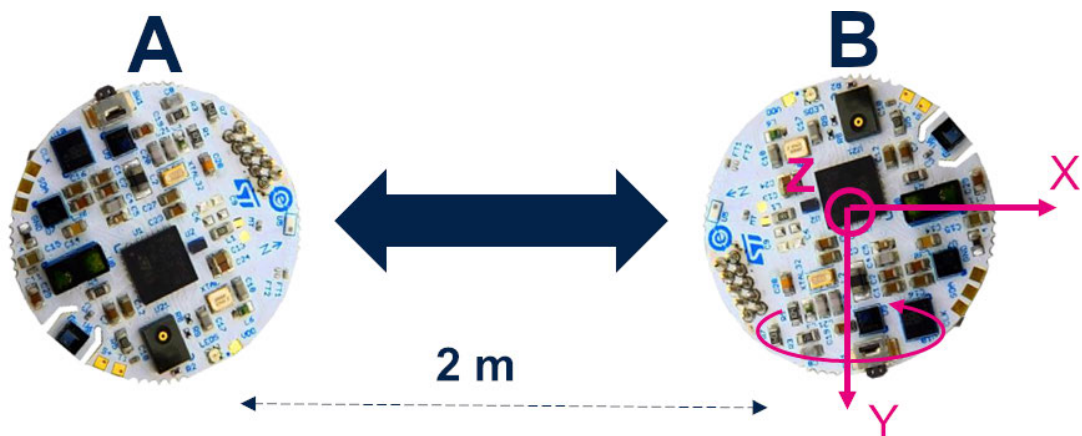

Table 4. Results for tilting the Z-X plane of the receiver

Test Scenario	θ_x deg	θ_y deg	θ_z deg	RSSI	Distance	% Error
Node B rotate along Y-Axis (STEVAL-BCN002V1)	0	0	0	-70.43	2288.22	12.59
	45	0	45	-64.78	1896.82	-5.43
	90	0	90	-70.03	2259.23	11.47
	45	0	135	-68.93	2131.34	6.16
	0	0	180	-69.11	2133.14	6.24

Table 5. Results for tilting the Z-Y plane of the receiver

Test Scenario	θ_x deg	θ_y deg	θ_z deg	RSSI	Distance	% Error
Node B rotation along X-Axis (STEVAL-BCN002V1)	0	0	0	-70.43	2288.22	12.59
	0	45	45	-70.05	2251.90	11.18
	0	90	90	-59.99	1840.60	-8.66
	0	45	135	-69.70	2212.35	9.59
	0	0	180	-66.62	1852.03	-7.98

4.2 Impact of relative node position on RSSI

This test observed how the position of transmitter Node B with respect to the antenna on Node A impacted RSSI at a constant distance of approximately 2 meters.

Several RSSI sample measurements are taken for each position of Node B in a circle around Node A, without any appreciable tilt, and the magnitude of the error between the distances derived from RSSI and actual distances is determined.

Figure 12. Node positioning with respect to a fixed node

- 1. SMD antenna
- A. Node A in fixed position
- B1-B4. Different positions of Node B around Node A (0°, 90°, 180°, 270°)

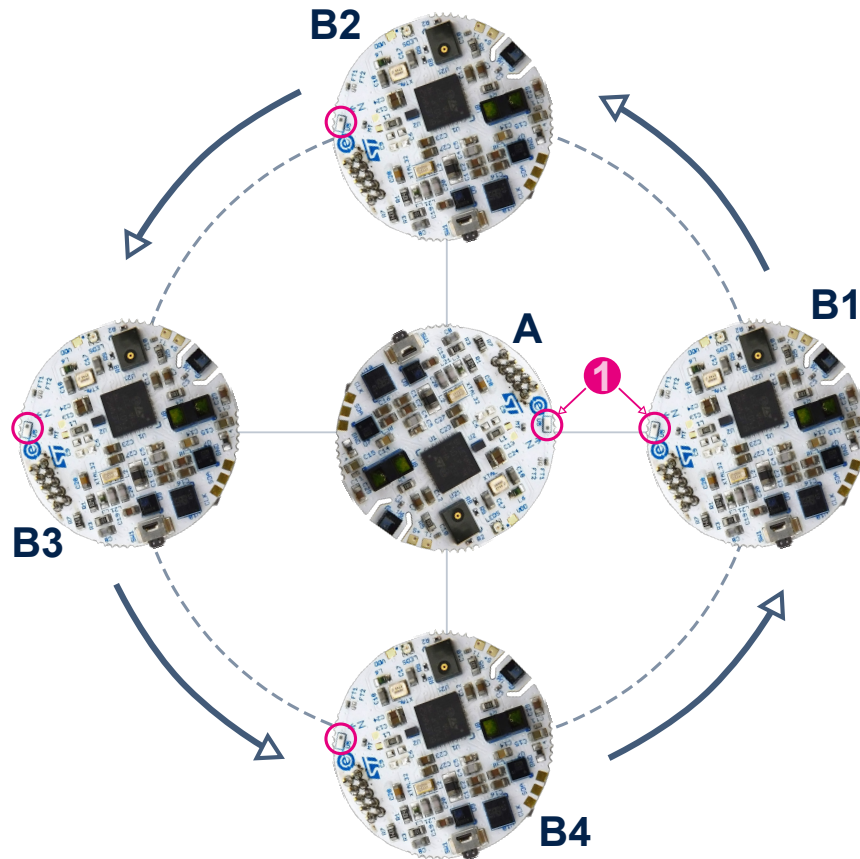

Table 6. Result for different positions of Node B around Node A

Test Scenario	X (0°)	Y (0°)	Z (0°)	RSSI	Distance	Error (%)
Node B at 0° (line of sight)	0	0	0	-69.91	2246.73	10.98
Node B at 90°	0	0	0	-69.05	2138.70	6.48
Node B at 180°	0	0	0	-67.04	1891.32	-5.74
Node B at 270°	0	0	0	-69.76	2227.58	10.21

Revision history

Table 7. Document revision history

Date	Version	Changes
01-Jun-2020	1	Initial release.

Contents

1	iBeacon standard	2
2	Overview of proximity detection	3
2.1	System startup and initialization	3
2.2	System operation	4
2.3	RSSI filtering techniques	5
2.3.1	Weighted mean filter	5
2.3.2	Average filter	6
2.4	Accounting for tilt angles	6
3	Device operating modes	8
3.1	High probability detection	8
3.2	Low power operation	8
3.2.1	No beacon detected	8
3.2.2	No movement detected from accelerometer	9
4	Test results	11
4.1	Impact of node rotation along an axis on RSSI	11
4.2	Impact of relative node position on RSSI	11
	Revision history	13

List of figures

Figure 1.	Distance zones	1
Figure 2.	iBeacon advertising packet	2
Figure 3.	Proximity detection based on RSSI	3
Figure 4.	Flowchart of algorithm logic	4
Figure 5.	Advertising intervals and scan windows	5
Figure 6.	Advertising and scanning	5
Figure 7.	RSSI signal strength over distance	7
Figure 8.	High detection scanning and advertising intervals	8
Figure 9.	Low Power Mode activation	9
Figure 10.	No movement detection logic	10
Figure 11.	Node rotation along an axis	11
Figure 12.	Node positioning with respect to a fixed node	12

List of tables

Table 1.	Default advertising and scanning intervals	3
Table 2.	RSSI lookup table	7
Table 3.	Accelerometer register configuration for wake-up event	9
Table 4.	Results for tilting the Z-X plane of the receiver	11
Table 5.	Results for tilting the Z-Y plane of the receiver	11
Table 6.	Result for different positions of Node B around Node A	12
Table 7.	Document revision history	13

IMPORTANT NOTICE – PLEASE READ CAREFULLY

STMicroelectronics NV and its subsidiaries (“ST”) reserve the right to make changes, corrections, enhancements, modifications, and improvements to ST products and/or to this document at any time without notice. Purchasers should obtain the latest relevant information on ST products before placing orders. ST products are sold pursuant to ST’s terms and conditions of sale in place at the time of order acknowledgement.

Purchasers are solely responsible for the choice, selection, and use of ST products and ST assumes no liability for application assistance or the design of Purchasers’ products.

No license, express or implied, to any intellectual property right is granted by ST herein.

Resale of ST products with provisions different from the information set forth herein shall void any warranty granted by ST for such product.

ST and the ST logo are trademarks of ST. For additional information about ST trademarks, please refer to www.st.com/trademarks. All other product or service names are the property of their respective owners.

Information in this document supersedes and replaces information previously supplied in any prior versions of this document.

© 2020 STMicroelectronics – All rights reserved