

## Silicon carbide Power MOSFET 650 V, 55 mΩ typ., 45 A in an HiP247-4 package

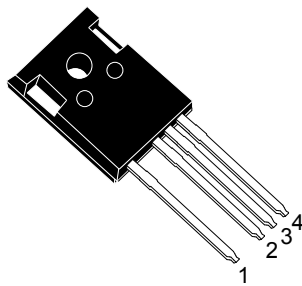

HiP247-4

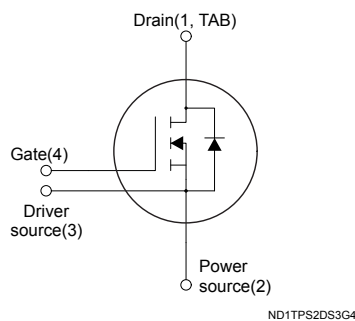

## Features

Order code	V <sub>DS</sub>	R <sub>DS(on)</sub> max.	I <sub>D</sub>
SCTWA35N65G2V-4	650 V	67 mΩ	45 A

- Very fast and robust intrinsic body diode
- Low capacitances
- Source sensing pin for increased efficiency
- Very high operating junction temperature capability (T<sub>J</sub> = 200 °C)

## Applications

- Switching mode power supply
- DC-DC converters
- Industrial motor control

## Description

This silicon carbide Power MOSFET device has been developed using ST's advanced and innovative 2<sup>nd</sup> generation SiC MOSFET technology. The device features remarkably low on-resistance per unit area and very good switching performance. The variation of switching loss is almost independent of junction temperature.

## Product status link

[SCTWA35N65G2V-4](#)

## Product summary

Order code	SCTWA35N65G2V-4
Marking	SCT35N65G2V
Package	HiP247-4
Packing	Tube

# 1 Electrical ratings

**Table 1. Absolute maximum ratings**

Symbol	Parameter	Value	Unit
$V_{DS}$	Drain-source voltage	650	V
$V_{GS}$	Gate-source voltage	-10 to 22	V
	Gate-source voltage (recommended operating range)	-5 to 18	
$I_D$	Drain current (continuous) at $T_C = 25\text{ °C}$	45	A
	Drain current (continuous) at $T_C = 100\text{ °C}$	35	
$I_{DM}^{(1)}$	Drain current (pulsed)	90	A
$P_{TOT}$	Total power dissipation at $T_C = 25\text{ °C}$	240	W
$T_{stg}$	Storage temperature range	-55 to 200	°C
$T_J$	Operating junction temperature range		°C

1. Pulse width is limited by safe operating area.

**Table 2. Thermal data**

Symbol	Parameter	Value	Unit
$R_{thJC}$	Thermal resistance, junction-to-case	0.72	°C/W
$R_{thJA}$	Thermal resistance, junction-to-ambient	40	°C/W

## 2 Electrical characteristics

( $T_C = 25\text{ °C}$  unless otherwise specified).

**Table 3. On/off states**

Symbol	Parameter	Test conditions	Min.	Typ.	Max.	Unit
$V_{(BR)DSS}$	Drain-source breakdown voltage	$V_{GS} = 0\text{ V}$ , $I_D = 1\text{ mA}$	650			V
$I_{DSS}$	Zero gate voltage drain current	$V_{GS} = 0\text{ V}$ , $V_{DS} = 650\text{ V}$			5	$\mu\text{A}$
$I_{GSS}$	Gate-body leakage current	$V_{DS} = 0\text{ V}$ , $V_{GS} = -10\text{ to }22\text{ V}$			$\pm 100$	nA
$V_{GS(th)}$	Gate threshold voltage	$V_{DS} = V_{GS}$ , $I_D = 1\text{ mA}$	1.8	3.2	5	V
$R_{DS(on)}$	Static drain-source on-resistance	$V_{GS} = 20\text{ V}$ , $I_D = 20\text{ A}$		45	67	m $\Omega$
		$V_{GS} = 18\text{ V}$ , $I_D = 20\text{ A}$		55		
		$V_{GS} = 20\text{ V}$ , $I_D = 20\text{ A}$ , $T_J = 200\text{ °C}$		68		

**Table 4. Dynamic, based on HiP247 package option**

Symbol	Parameter	Test conditions	Min.	Typ.	Max.	Unit
$C_{iss}$	Input capacitance	$V_{GS} = 0\text{ V}$ , $V_{DS} = 400\text{ V}$ , $f = 1\text{ MHz}$	-	1370	-	pF
$C_{oss}$	Output capacitance		-	125	-	pF
$C_{rss}$	Reverse transfer capacitance		-	30	-	pF
$R_g$	Gate input resistance	$f = 1\text{ MHz}$ , $I_D = 0\text{ A}$	-	2	-	$\Omega$
$Q_g$	Total gate charge	$V_{DD} = 400\text{ V}$ , $I_D = 20\text{ A}$ , $V_{GS} = 0\text{ to }20\text{ V}$	-	73	-	nC
$Q_{gs}$	Gate-source charge		-	14	-	nC
$Q_{gd}$	Gate-drain charge		-	27	-	nC

**Table 5. Switching energy (inductive load), based on HiP247 package option**

Symbol	Parameter	Test conditions	Min.	Typ.	Max.	Unit
$E_{on}$	Turn-on switching energy	$V_{DD} = 400\text{ V}$ , $I_D = 20\text{ A}$ ,	-	100	-	$\mu\text{J}$
$E_{off}$	Turn-off switching energy	$R_G = 4.7\text{ }\Omega$ , $V_{GS} = -5\text{ to }20\text{ V}$	-	35	-	$\mu\text{J}$

**Table 6. Switching times, based on HiP247 package option**

Symbol	Parameter	Test conditions	Min.	Typ.	Max.	Unit
$t_{d(on)}$	Turn-on delay time	$V_{DD} = 400\text{ V}$ , $I_D = 20\text{ A}$ , $R_G = 4.7\text{ }\Omega$ , $V_{GS} = -5\text{ to }20\text{ V}$	-	16	-	ns
$t_f$	Fall time		-	14	-	ns
$t_{d(off)}$	Turn-off delay time		-	35	-	ns
$t_r$	Rise time		-	9	-	ns

**Table 7. Reverse diode characteristics, based on HiP247 package option**

Symbol	Parameter	Test conditions	Min.	Typ.	Max.	Unit
$V_{SD}$	Forward on voltage	$V_{GS} = 0\text{ V}$ , $I_F = 20\text{ A}$ ,	-	3.3	-	V
$t_{rr}$	Reverse recovery time	$V_{DD} = 400\text{ V}$ , $I_F = 20\text{ A}$ , $di/dt = 1000\text{ A}/\mu\text{s}$	-	18	-	ns
$Q_{rr}$	Reverse recovery charge		-	85	-	nC
$I_{RRM}$	Reverse recovery current		-	7	-	A

## 2.1 Electrical characteristics (curves), based on HiP247 package option

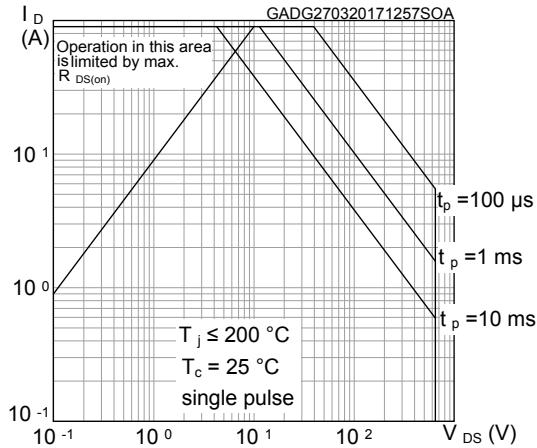
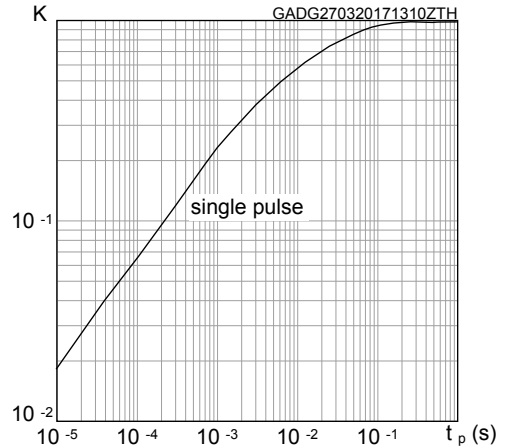
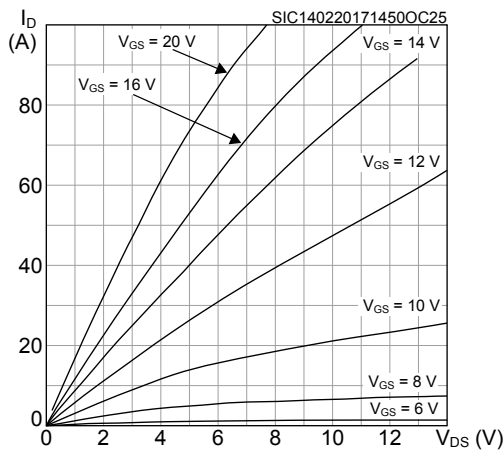
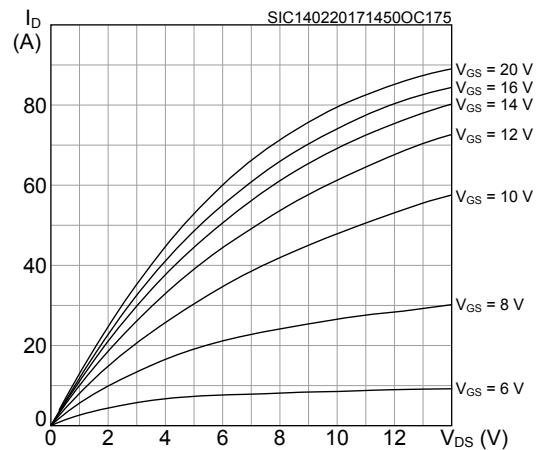
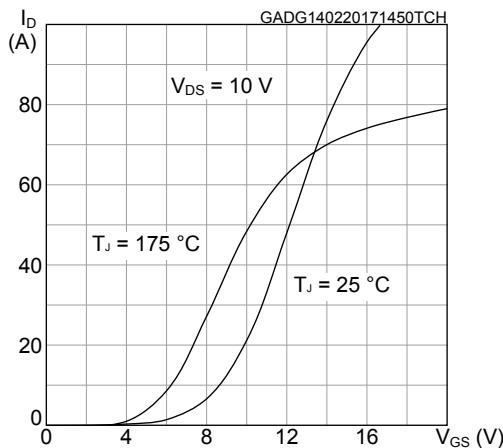
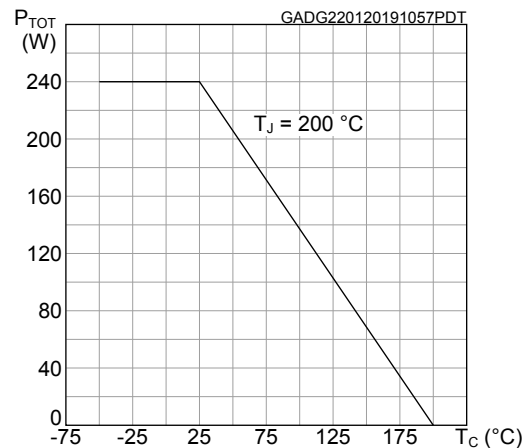
**Figure 1. Safe operating area**

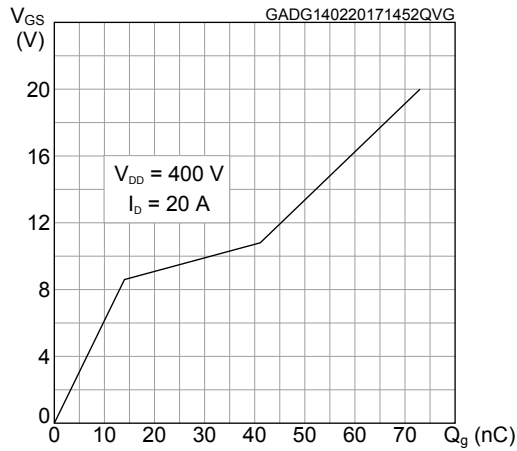
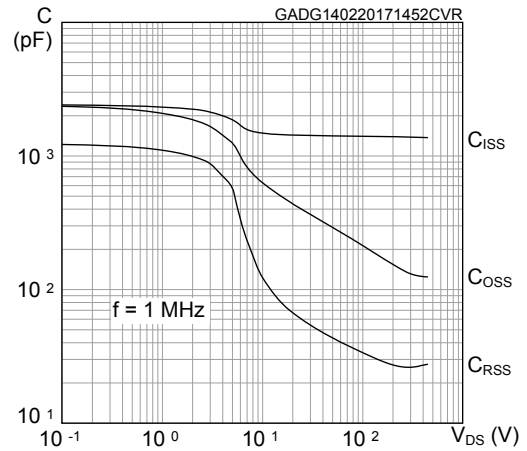
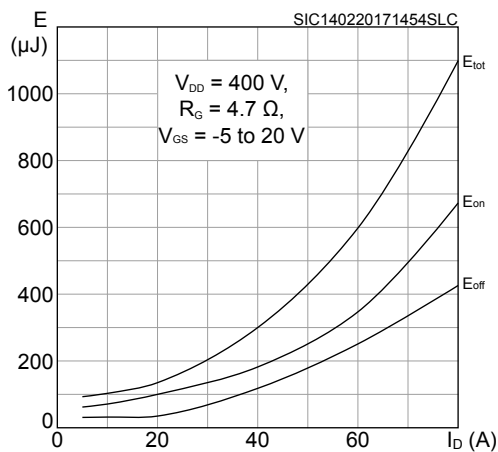
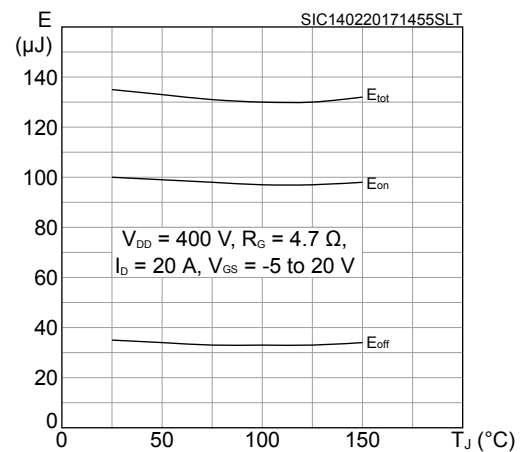
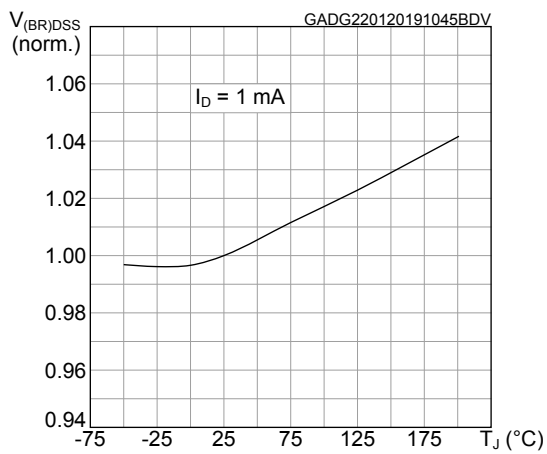
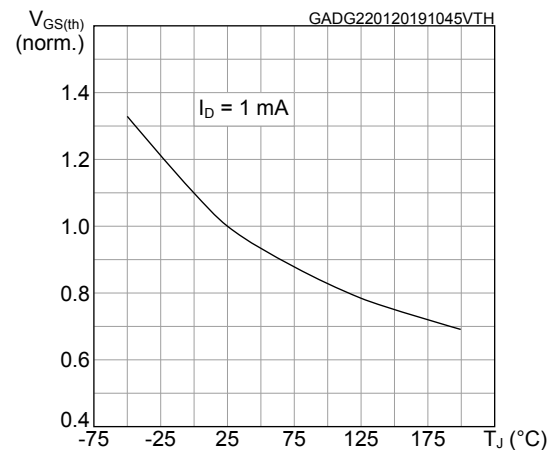
**Figure 2. Normalized thermal impedance**

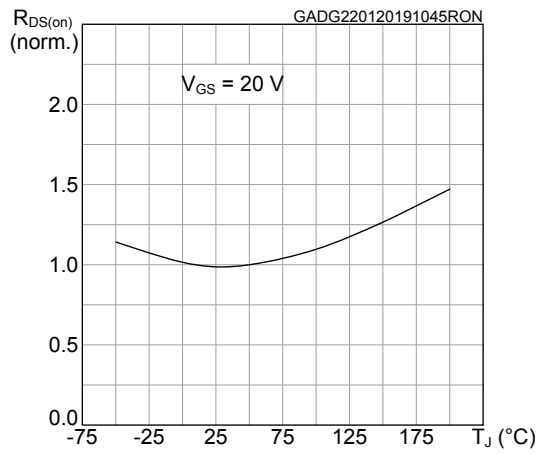
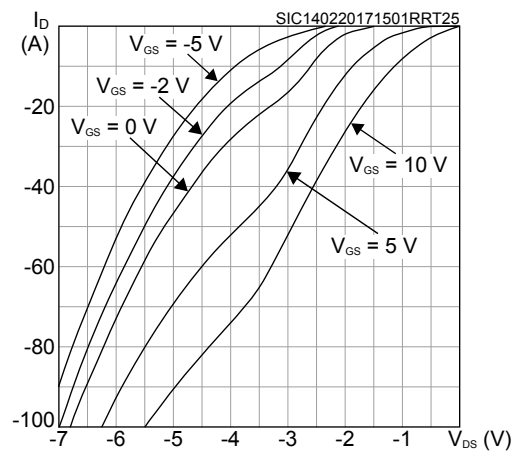
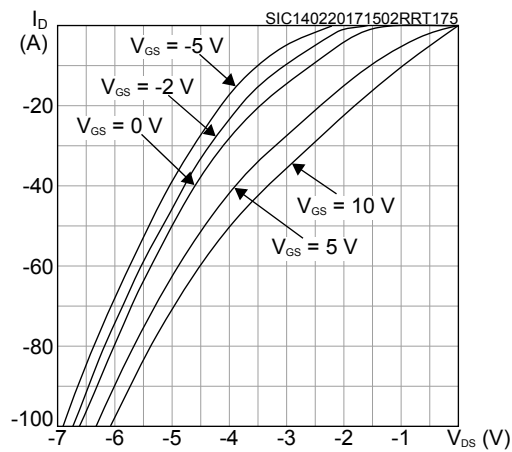
**Figure 3. Output characteristics ( $T_J = 25\text{ }^\circ\text{C}$ )**

**Figure 4. Output characteristics ( $T_J = 175\text{ }^\circ\text{C}$ )**

**Figure 5. Transfer characteristics**

**Figure 6. Power dissipation**

**Figure 7. Gate charge vs gate-source voltage**

**Figure 8. Capacitance variations**

**Figure 9. Switching energy vs drain current**

**Figure 10. Switching energy vs junction temperature**

**Figure 11. Normalized  $V_{(BR)DSS}$  vs temperature**

**Figure 12. Normalized gate threshold voltage vs temperature**

**Figure 13. Normalized on-resistance vs temperature**

**Figure 14. Reverse conduction characteristics ( $T_J = 25$  °C)**

**Figure 15. Reverse conduction characteristics ( $T_J = 175$  °C)**

### 3 Package information

In order to meet environmental requirements, ST offers these devices in different grades of **ECOPACK** packages, depending on their level of environmental compliance. ECOPACK specifications, grade definitions and product status are available at: [www.st.com](http://www.st.com). ECOPACK is an ST trademark.

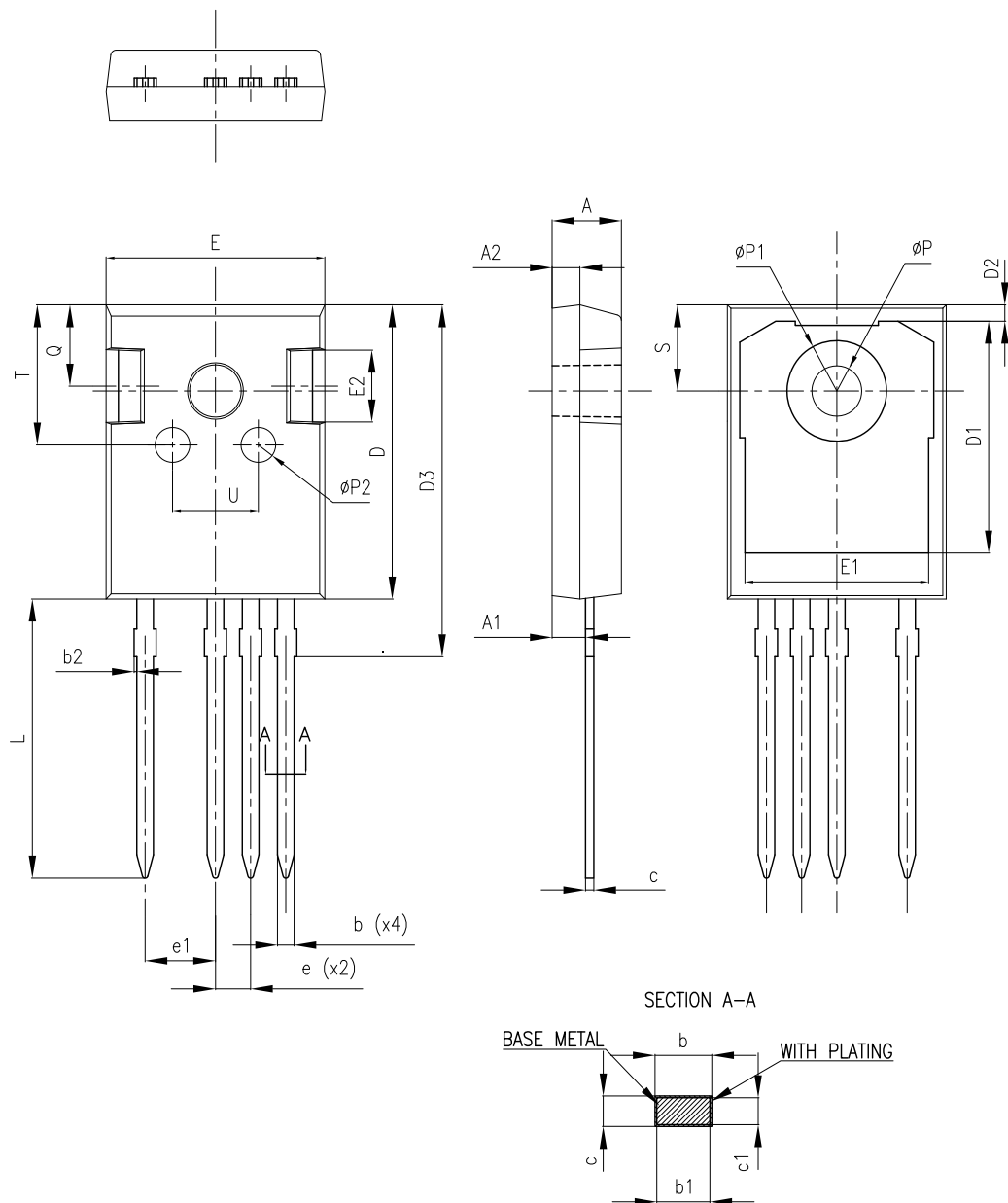
#### 3.1 HiP247-4 package information

Figure 16. HiP247-4 package outline



8405626\_2



**Table 8. HiP247-4 mechanical data**

Dim.	mm		
	Min.	Typ.	Max.
A	4.90	5.00	5.10
A1	2.31	2.41	2.51
A2	1.90	2.00	2.10
b	1.16		1.29
b1	1.15	1.20	1.25
b2	0		0.20
c	0.59		0.66
c1	0.58	0.60	0.62
D	20.90	21.00	21.10
D1	16.25	16.55	16.85
D2	1.05	1.20	1.35
D3	24.97	25.12	25.27
E	15.70	15.80	15.90
E1	13.10	13.30	13.50
E2	4.90	5.00	5.10
E3	2.40	2.50	2.60
e	2.44	2.54	2.64
e1	4.98	5.08	5.18
L	19.80	19.92	20.10
P	3.50	3.60	3.70
P1			7.40
P2	2.40	2.50	2.60
Q	5.60		6.00
S		6.15	
T	9.80		10.20
U	6.00		6.40

## Revision history

**Table 9. Document revision history**

Date	Version	Changes
02-Dec-2020	1	First release.

---

## Contents

<b>1</b>	<b>Electrical ratings</b> .....	<b>2</b>
<b>2</b>	<b>Electrical characteristics</b> .....	<b>3</b>
<b>2.1</b>	Electrical characteristics (curves), based on HiP247 package option .....	5
<b>3</b>	<b>Package information</b> .....	<b>8</b>
<b>3.1</b>	HiP247-4 package information .....	8
	<b>Revision history</b> .....	<b>10</b>

**IMPORTANT NOTICE – PLEASE READ CAREFULLY**

STMicroelectronics NV and its subsidiaries (“ST”) reserve the right to make changes, corrections, enhancements, modifications, and improvements to ST products and/or to this document at any time without notice. Purchasers should obtain the latest relevant information on ST products before placing orders. ST products are sold pursuant to ST’s terms and conditions of sale in place at the time of order acknowledgement.

Purchasers are solely responsible for the choice, selection, and use of ST products and ST assumes no liability for application assistance or the design of Purchasers’ products.

No license, express or implied, to any intellectual property right is granted by ST herein.

Resale of ST products with provisions different from the information set forth herein shall void any warranty granted by ST for such product.

ST and the ST logo are trademarks of ST. For additional information about ST trademarks, please refer to [www.st.com/trademarks](http://www.st.com/trademarks). All other product or service names are the property of their respective owners.

Information in this document supersedes and replaces information previously supplied in any prior versions of this document.

© 2020 STMicroelectronics – All rights reserved