

### Introduction

The STM8S-DISCOVERY is a quick start evaluation board which helps you to discover the STM8 features, and to develop and share your own application. It is based on an STM8S105 and includes an embedded debugger, ST-LINK, and a touch sensing button. Numerous applications are available from the STM8S-Discovery web page.

### Features

- STM8S105C6T6 microcontroller, 32 KB Flash, 2 KB RAM, 1 KB EEPROM
- Powered by USB cable between PC and STM8S-DISCOVERY
- Selectable power of 5 V or 3.3 V
- Touch Sensing button, TS1
- User LED, LD1
- Extension header for all I/Os
- Wrapping area for users own application
- Embedded ST-LINK for STM8S
- USB interface for programming and debugging
- SWIM debug support

**Figure 1. STM8S-DISCOVERY evaluation board**

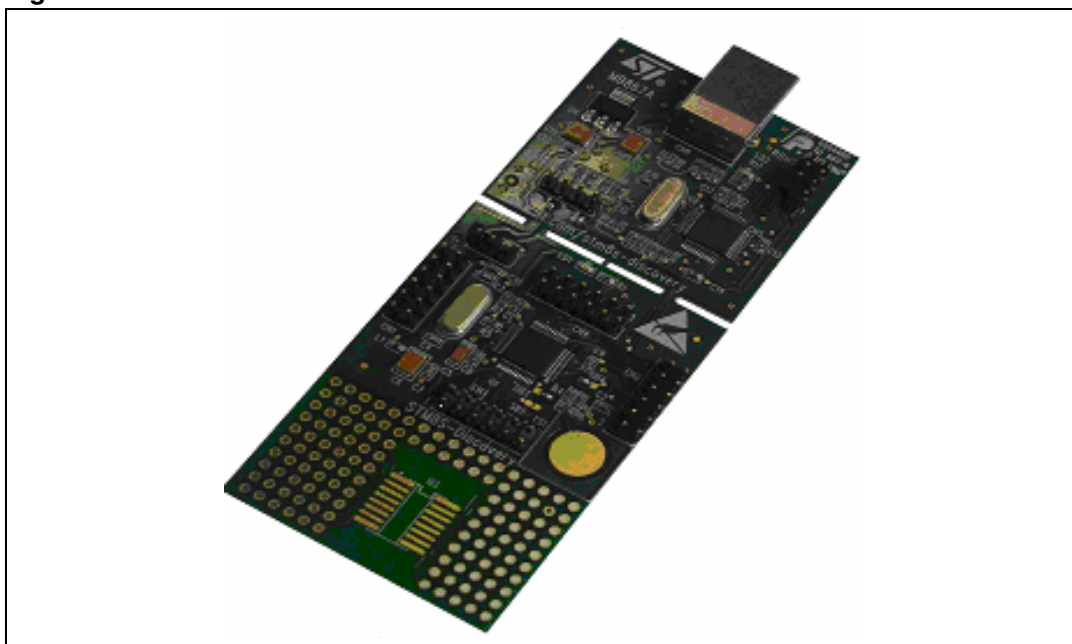

---

# Contents

<b>1</b>	<b>Quick start</b> .....	<b>3</b>
<b>2</b>	<b>Hardware and layout</b> .....	<b>4</b>
2.1	STM8S105C6T6 microcontroller .....	6
2.2	ST-LINK .....	8
2.2.1	Using the ST-LINK .....	8
2.2.2	Using the ST-LINK on other STM8S applications .....	8
2.3	Power supply and power selection .....	9
2.4	Single touch sensing .....	10
<b>3</b>	<b>Daughterboard connection</b> .....	<b>11</b>
<b>4</b>	<b>Mechanical drawing</b> .....	<b>13</b>
<b>5</b>	<b>Electrical schematics</b> .....	<b>14</b>
<b>6</b>	<b>Revision history</b> .....	<b>17</b>

# 1 Quick start

It is very simple to get started using the STM8S-DISCOVERY, just follow these four steps:

1. Connect the STM8S-DISCOVERY to a PC with a USB cable.
2. Press the TS1 button, and observe LED LD1 blinking.
3. Press the TS1 button to change blinking speed.
4. Visit [www.st.com/stm8s-discovery](http://www.st.com/stm8s-discovery) and follow the tutorial, then discover other applications.

The STM8S-DISCOVERY helps you develop and share your own application.

You can discover more of the STM8S features by downloading and executing the proposed programs in the project list.

*Note:* The software code corresponding to this application is available under the name **Discover** in the project list of the STM8S-Discovery web page.

## 2 Hardware and layout

The STM8S-DISCOVERY is designed around the STM8S105C6T6 microcontroller in an LQFP48 package. It has two distinct sections that may be separated, the STM8S105C6T6 module and the ST-LINK module.

*Figure 2* illustrates the connections between the STM8S105C6T6 and its peripherals (ST-LINK, touch-sensing button, LED and connectors).

*Figure 3* helps you to locate these features on the STM8S-DISCOVERY board, as well as the potential point of separation (for more details refer to [Section 2.2.2: Using the ST-LINK on other STM8S applications](#)).

**Figure 2. Hardware block diagram**

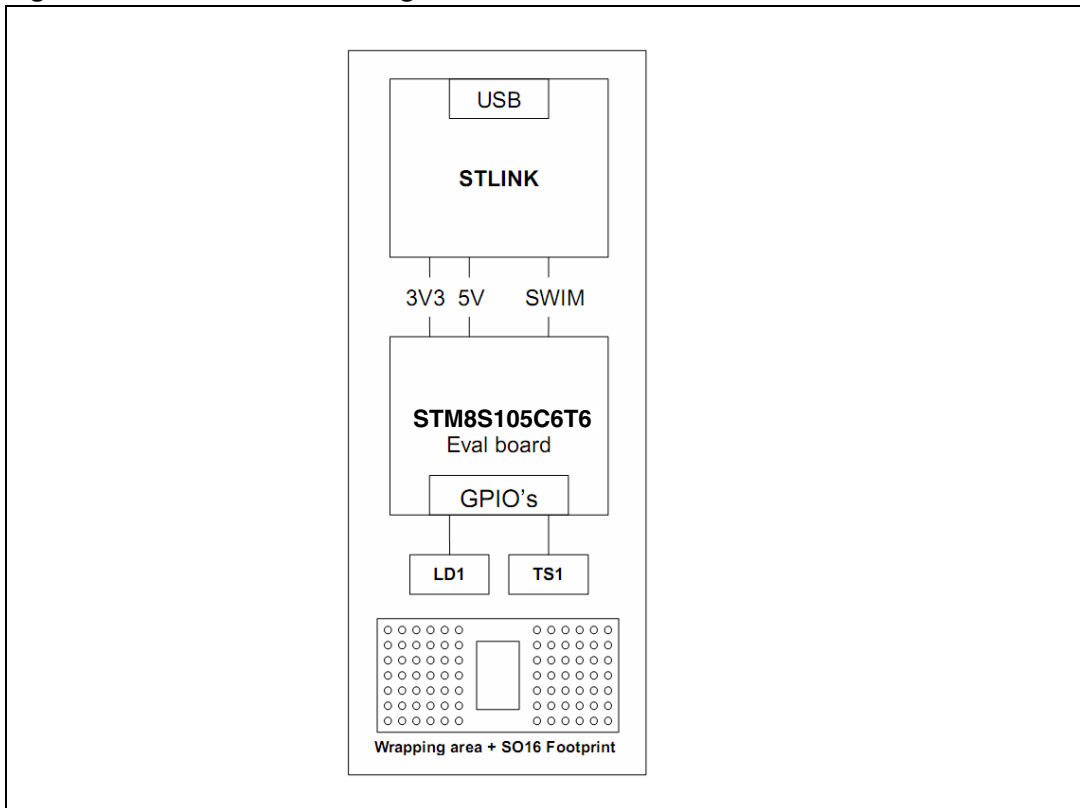
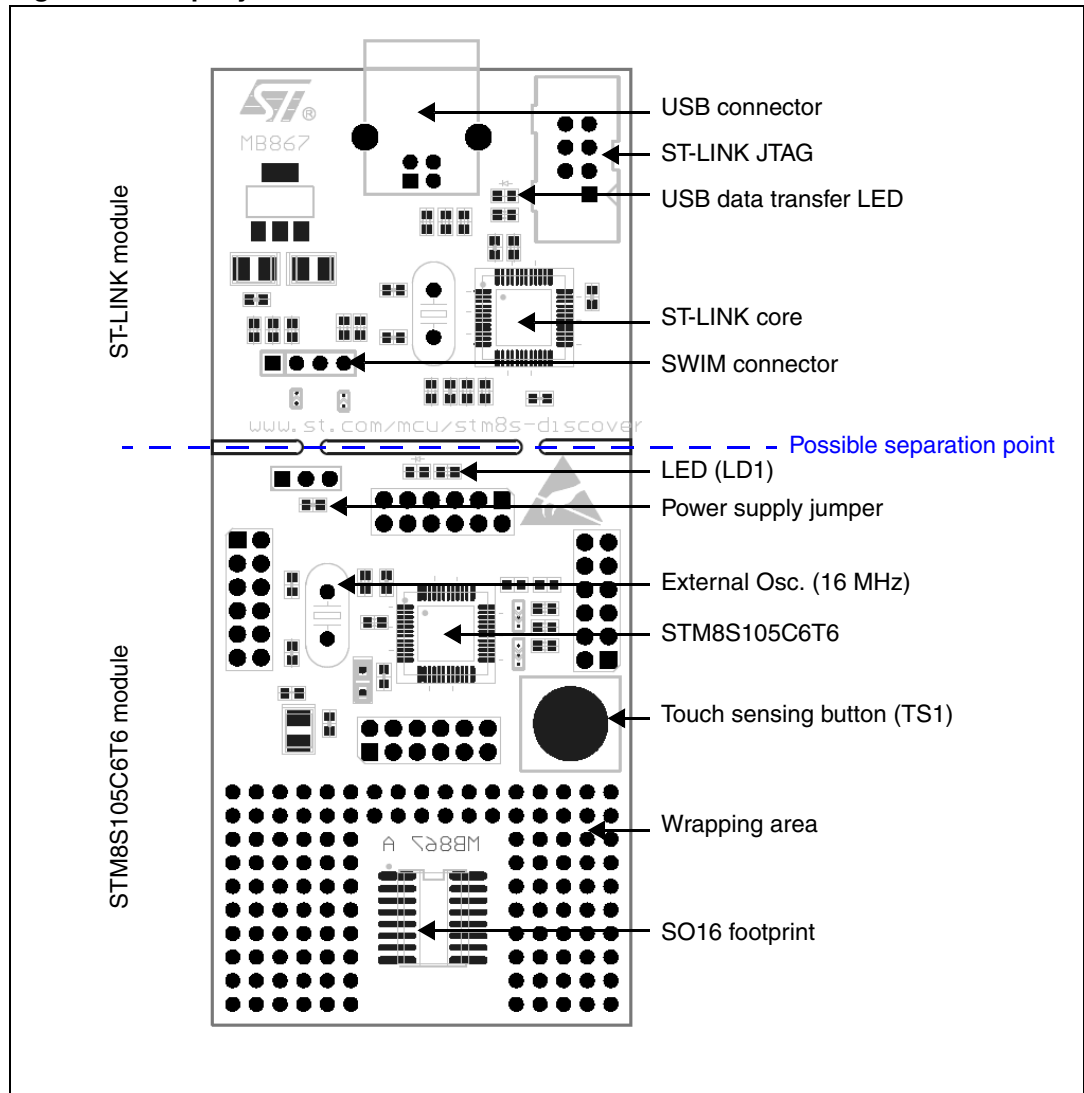
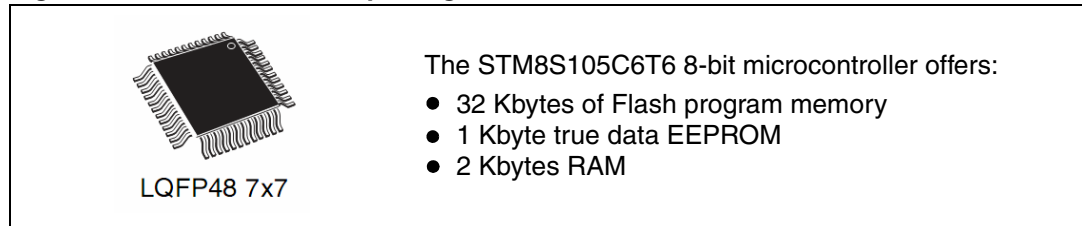

Figure 3. Top layout



## 2.1 STM8S105C6T6 microcontroller

Figure 4. STM8S105C6T6 package



This device provides the following benefits:

- Reduced system cost
  - Integrated true data EEPROM for up to 300 K write/erase cycles
  - High system integration level; internal clock oscillators, brown-out reset, watchdog.
- Performance and robustness
  - 16 MHz CPU clock frequency
  - Up to 38 I/Os on a 48-pin package including 16 high sink outputs
  - Robust I/O immune against current injection
  - Independent watchdogs with separate clock source
  - Flexible clock control, 4 master clocks (HSI, LSI, HSE and external HSE)
  - Clock security system
  - A family of products for applications with 2.95 V to 5.5 V operating supply
- Short development cycles
  - Applications scalability across common family product architecture with compatible pinout, memory map and modular peripherals.
  - Full documentation and a wide choice of development tools
  - Standard S/W library for firmware and touch sensing development quick start
  - Numerous application notes and firmware examples available
- Product longevity
  - Advanced core and peripherals made in state-of-the-art technology
  - Low power modes (wait, active-halt, halt)
  - Auto wake-up timer for active halt
  - Permanently active, low consumption
- Other features
  - Nested interrupt controller with 32 interrupts
  - Up to 37 external interrupts on 6 vectors
  - 2 x 16-bit general purpose timers; with 2+3 CAPCOM channels (IC, OC or PWM)
  - Advanced control timer: 16-bit, 4 CAPCOM channels, 3 complementary outputs, dead-time insertion and flexible synchronization
  - 8-bit basic timer with 8-bit prescaler
  - UART with clock output for synchronous operation, Smartcard, IrDA, LIN
  - SPI interface up to 8 Mbit/s
  - I2C interface up to 400 Kbit/s
  - Analog-to-digital converter 10-bit,  $\pm 1$  LSB ADC with up to 10 multiplexed channels

Figure 5. STM8S105 block diagram

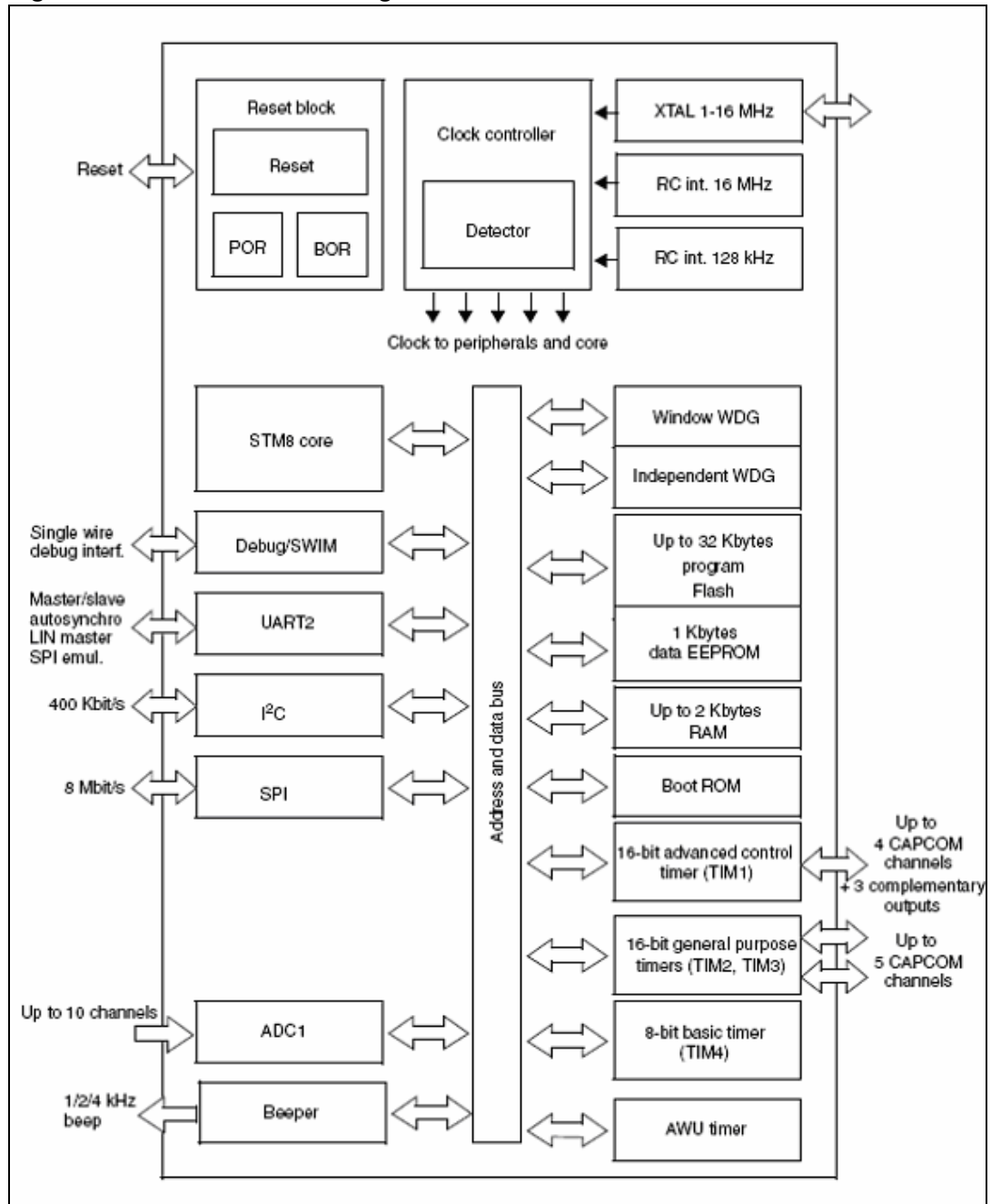

For more information see the STM8S105xx datasheet (Doc ID 14771) on the ST website.

## 2.2 ST-LINK

The ST-LINK provides a USB interface for programming and debugging using a single wire interface module (SWIM). The ST-LINK module of the STM8S-DISCOVERY also supplies 5 V and 3.3 V to the STM8S105C6T6 module.

### 2.2.1 Using the ST-LINK

Figure 6. Typical configuration

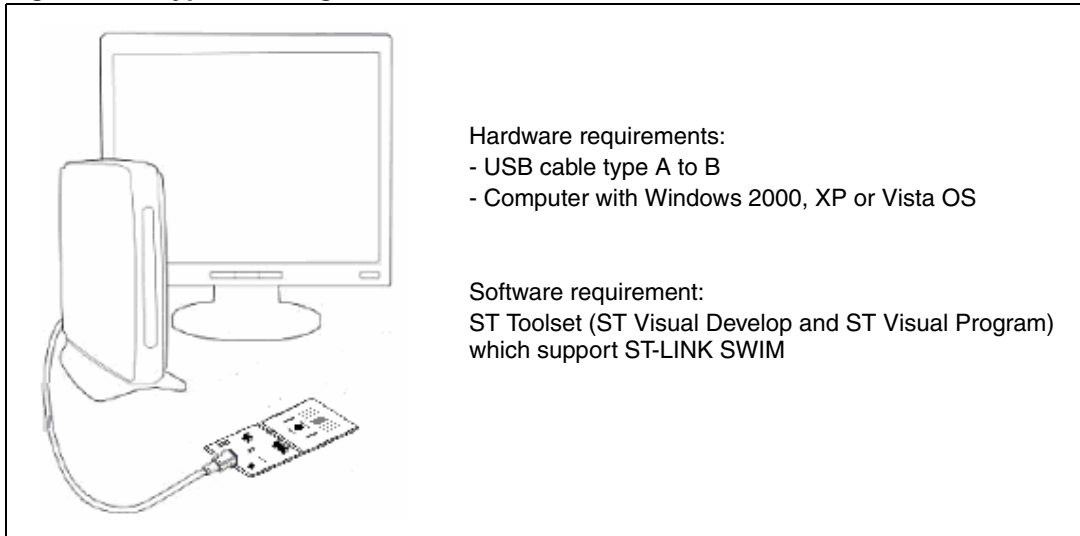

Note: The driver for ST-LINK is installed automatically when the USB is connected.

For information about debugging and programming features refer to ST-LINK UM0627, UM0036 STVD and RN0011 STVP. For information about SWIM refer to UM0470.

### 2.2.2 Using the ST-LINK on other STM8S applications

You can connect your ST-LINK to other STM8S applications in 2 ways.

- By removing the solder bridges: This way uses the ST-LINK without breaking the PCB. Unsolder the two solder bridges SB1 and SB2 under the SWIM connector. See [Figure 7](#). You can re-solder the two bridges at a later date thus keeping the STM8S-DISCOVERY usable.
- By removing it from your board: This way constitutes a good alternative to programming the STM8S devices in other applications. See [Figure 8](#).

Note: This ST-LINK only supports the STM8S family. Do not use it with other STM8 families.

Figure 7. ST-LINK without breaking the PCB

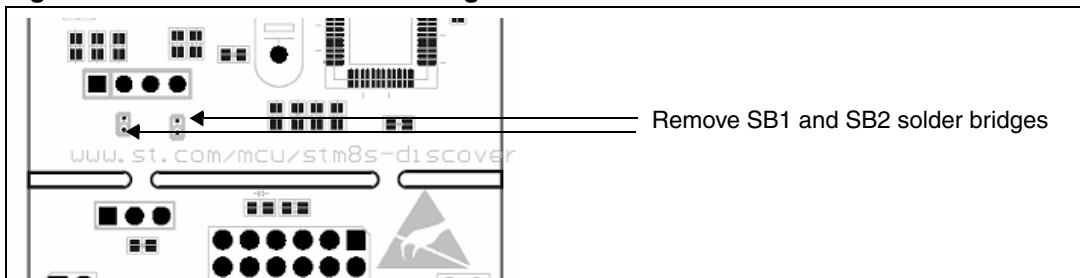
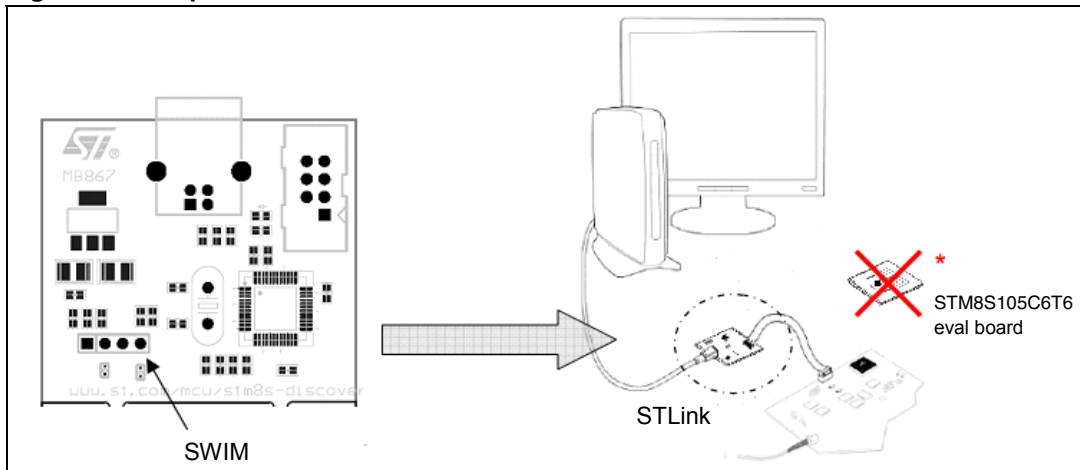



Figure 8. Separated ST-LINK module



**Warning:** By removing this module you will lose power supply on the STM8S105C6T6 evaluation board. In consequence, you will not be able to program and use the STM8S105C6T6 board without a SWIM cable and an external power supply.

To reconnect your STM8S105C6T6 use connector CNn see [Section 3: Daughterboard connection](#).

### 2.3 Power supply and power selection

The power supply is provided by a USB connector. Jumper JP1 selects the VDD value (5 V or regulated 3.3 V) see [Figure 9](#).

Figure 9. Power selection

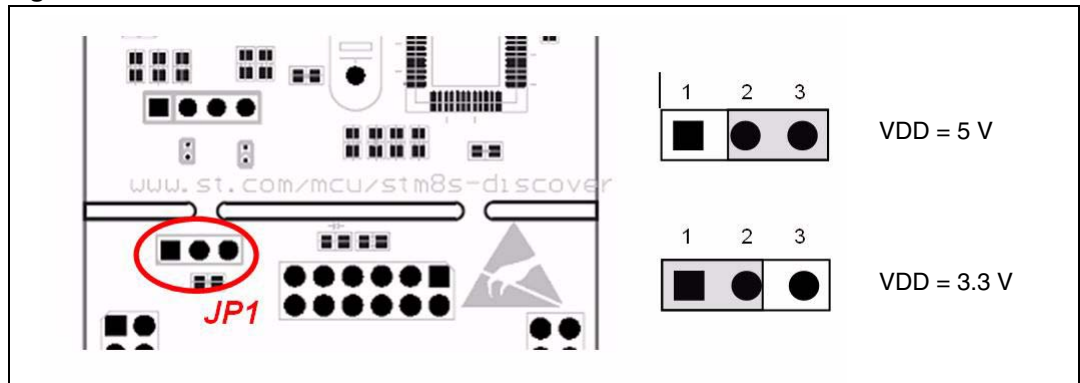

## 2.4 Single touch sensing

A touch sensing button TS1 is available on the STM8S-DISCOVERY (see [Figure 10](#)).

**Figure 10. Touch sensing schematic**

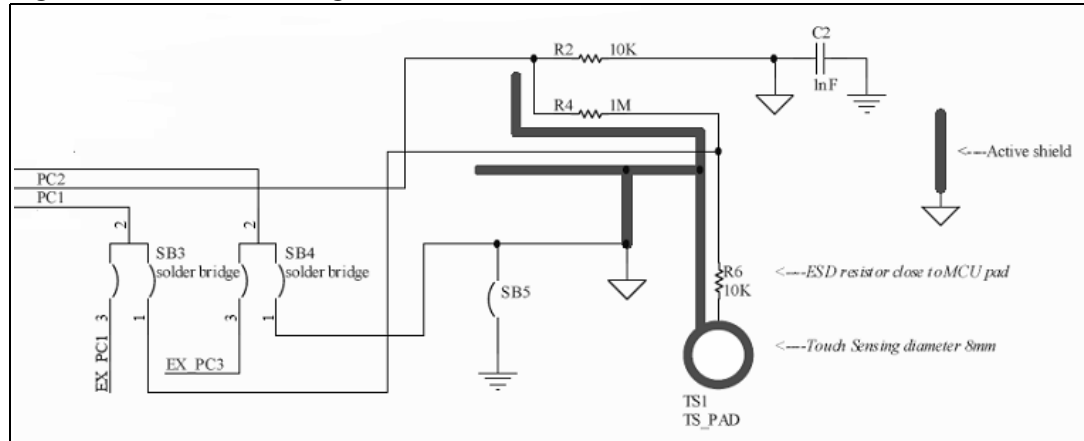

To disable the touch sensing interface and to use PC1, PC2 and PC3 as standard I/O, you need to unsolder the 2-1 connection and solder 2-3 connection on SB4 and SB3, you also need to unsolder the R2 resistor.

### RC acquisition principle

The RC acquisition method detects a human touch on key touch sensor (TS1) by measuring the small variation of the touch electrode capacitance. Electrode capacitance is periodically charged and discharged through a fixed resistor (R6).

The capacitance value depends on the following parameters: electrode area (A), relative dielectric constant of the insulator ( $\epsilon R$ ), the relative permittivity of air ( $\epsilon 0$ ) and the distance between the two electrodes.

For more information about touch sensing please refer to AN2927.

### 3 Daughterboard connection

Four 12-pin male headers CN1, CN2, CN3 and CN4 are connected to the STM8S105C6T6 microcontroller. See the following tables for pin assignments.

**Table 1. CN1 pinout**

Pin number (Cn1)	Pin number (chip)	Pin name	Type	Main function	Alternate function
1	1	NRST	IO	Reset	
2	2	OSCIN/PA1	IO	Port A1	
3	3	OSCOU/PA2	IO	Port A2	
4	4	Vssio_1	S	I/O ground	
5	5	Vss	S	Digital ground	
6	6	VCAP	S	1.8V regulator capacitor	
7	7	Vdd	S	Digital power supply	
8	8	Vddio_1	S	I/O power supply	
9	9	PA3	IO	Port A3	
10	10	PA4	IO	Port A4	
11	11	PA5	IO	Port A5	
12	12	PA6	IO	Port A6	

**Table 2. CN2 pinout**

Pin number (Cn2)	Pin number (chip)	Pin name	Type	Main function	Alternate function
1	25	PE5	IO	Port E5	SPI master / slave
2	26	PC1/TS1	IO	Port C1	Timer 1 - channel 1 / UART2 synchronous clock
3	27	PC2/TS1_load	IO	Port C2	Timer 1 - channel2
4	28	PC3	IO	Port C3	Timer 1 - channel 3
5	29	PC4	IO	Port C4	Timer 1 - channel 4
6	30	PC5	IO	Port C5	SPI clock
7	31	Vssio_2	S	I/O ground	
8	32	Vddio_2	S	I/O power supply	
9	33	PC6	IO	Port C6	SPI master out / slave in
10	34	PC7	IO	Port C7	SPI master in / slave out
11	35	PG0	IO	Port G0	
12	36	PG1	IO	Port G1	

**Table 3. CN3 pinout**

Pin number (Cn3)	Pin number (chip)	Pin name	Type	Main function	Alternate function
1	13	Vdda	S	Analog power supply	
2	14	Vssa	S	Analog ground	
3	15	PB7	IO	Port B7	Analog input 7
4	16	PB6	IO	Port B6	Analog input 6
5	17	PB5	IO	Port B5	Analog input 5
6	18	PB4	IO	Port B4	Analog input 4
7	19	PB3	IO	Port B3	Analog input 3
8	20	PB2	IO	Port B2	Analog input 2
9	21	PB1	IO	Port B1	Analog input 1
10	22	PB0	IO	Port B0	Analog input 0
11	23	PE7	IO	Port E7	Analog input 8
12	24	PE6	IO	Port E6	Analog input 9(2)

**Table 4. CN4 pinout**

Pin number (Cn4)	Pin number (chip)	Pin name	Type	Main function	Alternate function
1	37	PE3	IO	Port E3	Timer 1 – break Input
2	38	PE2	IO	Port E2	I2C data
3	39	PE1	IO	Port E1	I2C clock
4	40	PE0	IO	Port E0	Configurable clock output
5	41	PD0/LED	IO	Port D0	Timer 3 - channel 2
6	42	PD1/SWIM	IO	Port D1	SWIM data interface
7	43	PD2	IO	Port D2	Timer 3 - channel 1
8	44	PD3	IO	Port D3	Timer 2 - channel 2
9	45	PD4	IO	Port D4	Timer 2 - channel 1
10	46	PD5	IO	Port D5	UART2 data transmit
11	47	PD6	IO	Port D6	UART2 data receive
12	48	PD7	IO	Port D7	Top level interrupt

# 4 Mechanical drawing

Figure 11. STM8S-DISCOVERY

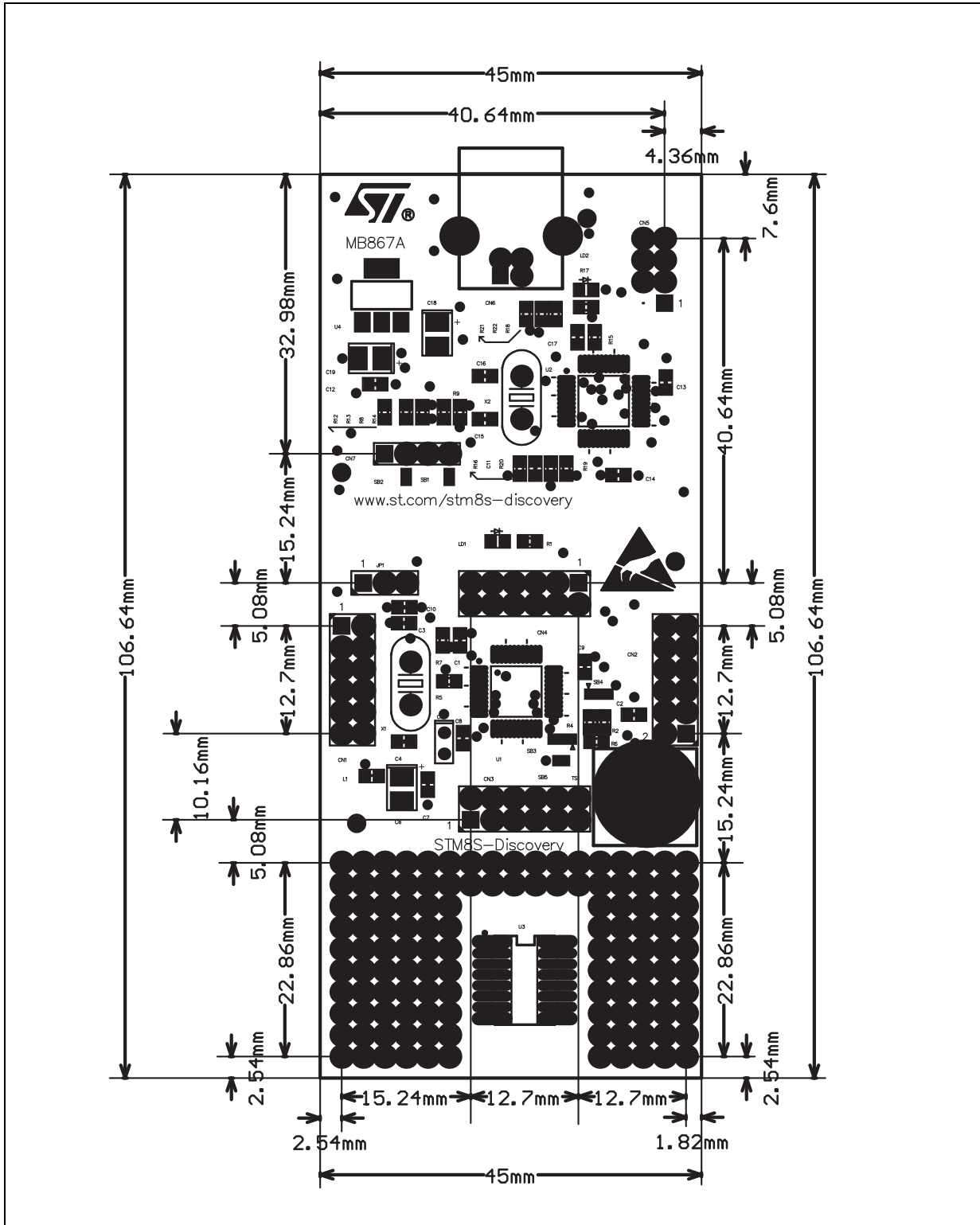



## 5 Electrical schematics

Figure 12. STM8S-DISCOVERY

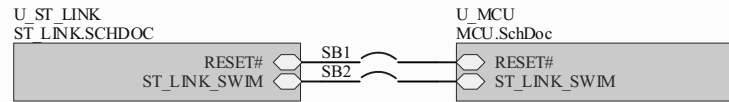

<b>STMicroelectronics</b>			
Title: <i>STM8S-Discovery</i>			
Number: MB867	Rev: A.1(PCB.SCH)	Date: 5/6/2009	Sheet 1 of 3



Figure 13. STM8S-DISCOVERY MCU

Doc ID 16361 Rev 3

15/18

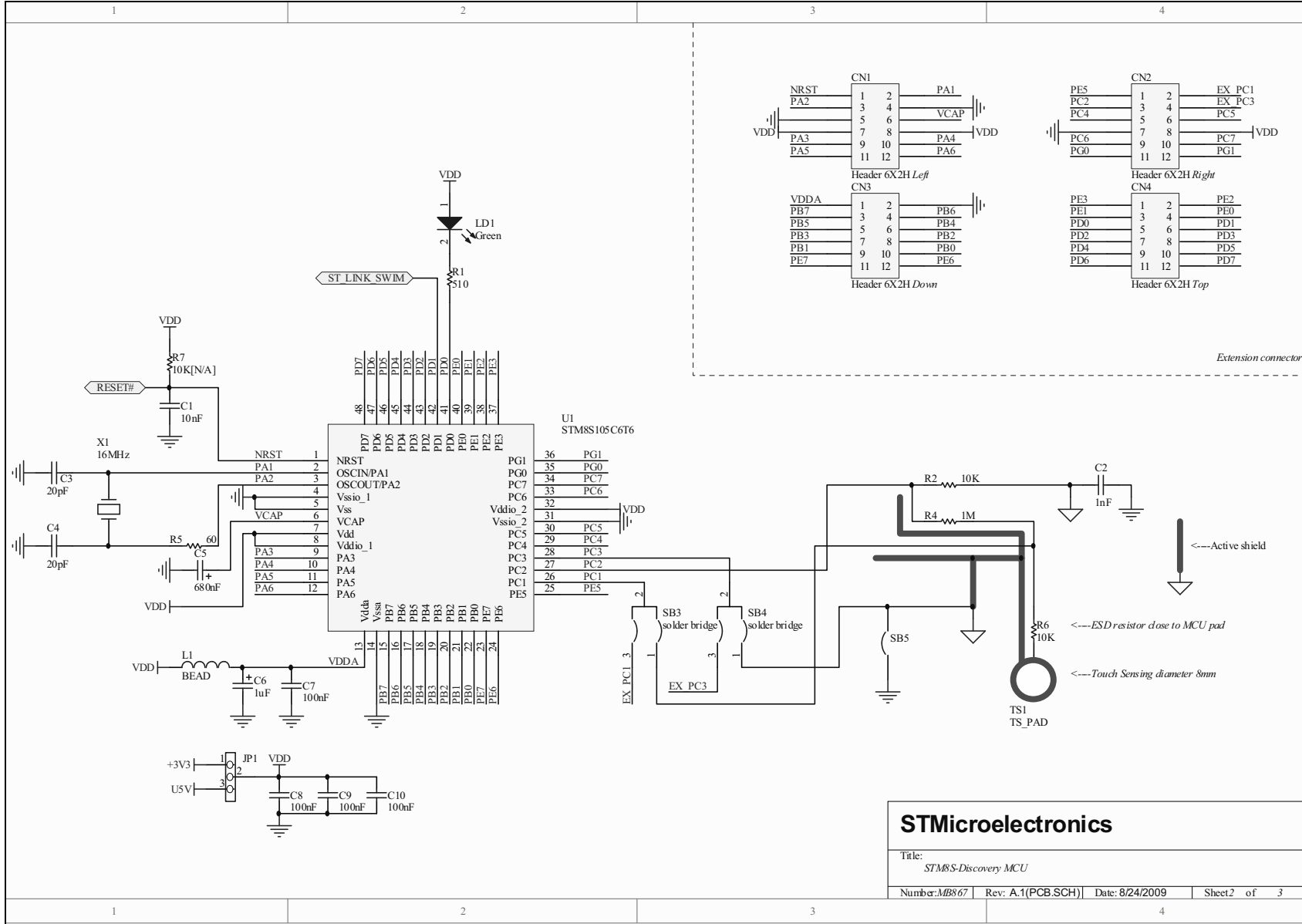

STMicroelectronics

Title: STM8S-Discovery MCU

Number: MB867 Rev: A.1(PCB.SCH) Date: 8/24/2009 Sheet 2 of 3

UM0817

Electrical schematics



Figure 14. STM8S-DISCOVERY ST-LINK (SWIM only)

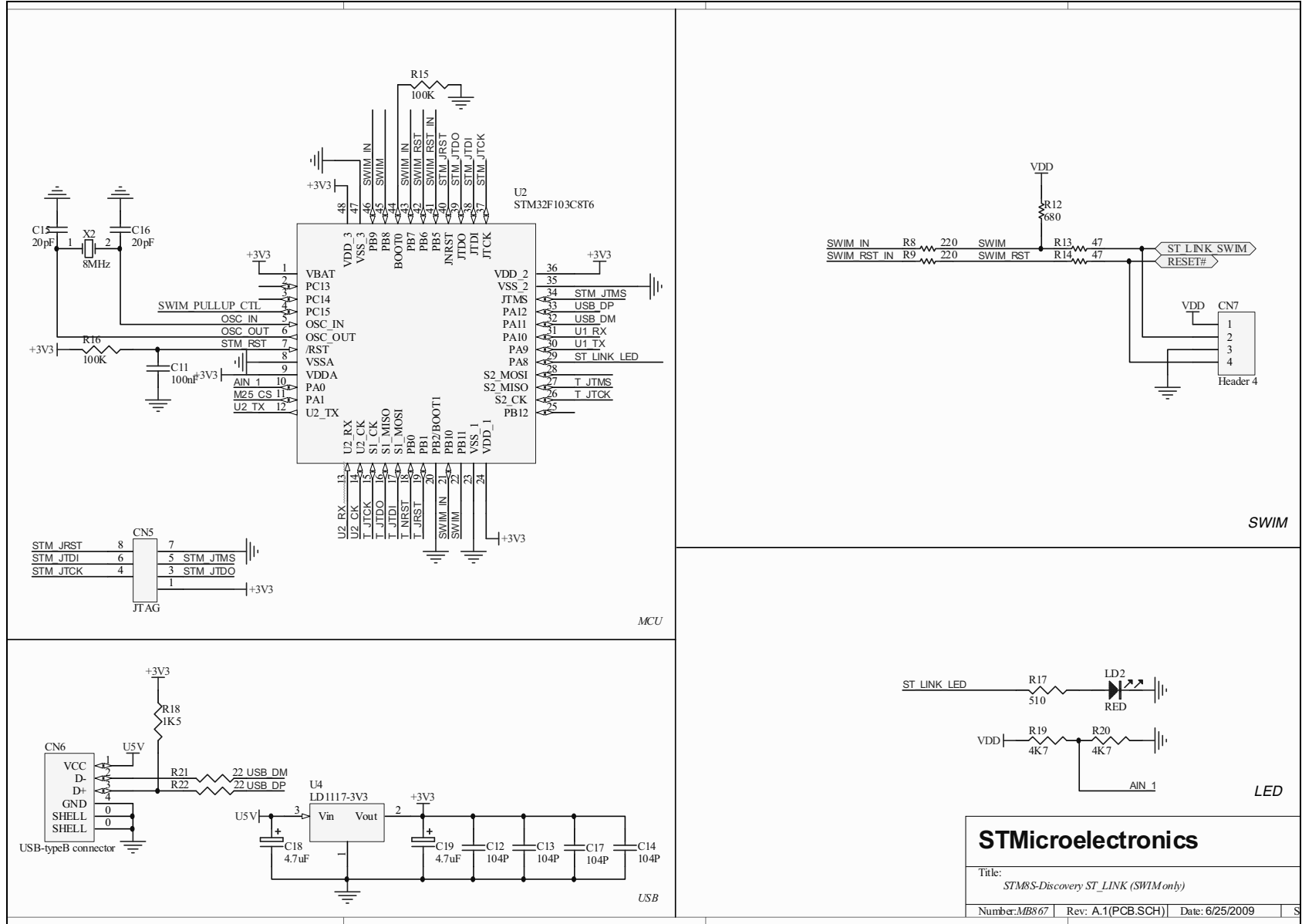

STMicroelectronics

Title:			
STM8S-Discovery ST_LINK (SWIM only)			
Number: MB867	Rev: A.1(PCB.SCH)	Date: 6/25/2009	S



## 6 Revision history

Table 5. Document revision history

Date	Revision	Changes
05-Oct-2009	1	Initial release.
22-Feb-2010	2	<a href="#">Section 2.4</a> modified.
28-Jul-2011	3	<a href="#">Section 4</a> added.

**Please Read Carefully:**

Information in this document is provided solely in connection with ST products. STMicroelectronics NV and its subsidiaries ("ST") reserve the right to make changes, corrections, modifications or improvements, to this document, and the products and services described herein at any time, without notice.

All ST products are sold pursuant to ST's terms and conditions of sale.

Purchasers are solely responsible for the choice, selection and use of the ST products and services described herein, and ST assumes no liability whatsoever relating to the choice, selection or use of the ST products and services described herein.

No license, express or implied, by estoppel or otherwise, to any intellectual property rights is granted under this document. If any part of this document refers to any third party products or services it shall not be deemed a license grant by ST for the use of such third party products or services, or any intellectual property contained therein or considered as a warranty covering the use in any manner whatsoever of such third party products or services or any intellectual property contained therein.

**UNLESS OTHERWISE SET FORTH IN ST'S TERMS AND CONDITIONS OF SALE ST DISCLAIMS ANY EXPRESS OR IMPLIED WARRANTY WITH RESPECT TO THE USE AND/OR SALE OF ST PRODUCTS INCLUDING WITHOUT LIMITATION IMPLIED WARRANTIES OF MERCHANTABILITY, FITNESS FOR A PARTICULAR PURPOSE (AND THEIR EQUIVALENTS UNDER THE LAWS OF ANY JURISDICTION), OR INFRINGEMENT OF ANY PATENT, COPYRIGHT OR OTHER INTELLECTUAL PROPERTY RIGHT.**

**UNLESS EXPRESSLY APPROVED IN WRITING BY TWO AUTHORIZED ST REPRESENTATIVES, ST PRODUCTS ARE NOT RECOMMENDED, AUTHORIZED OR WARRANTED FOR USE IN MILITARY, AIR CRAFT, SPACE, LIFE SAVING, OR LIFE SUSTAINING APPLICATIONS, NOR IN PRODUCTS OR SYSTEMS WHERE FAILURE OR MALFUNCTION MAY RESULT IN PERSONAL INJURY, DEATH, OR SEVERE PROPERTY OR ENVIRONMENTAL DAMAGE. ST PRODUCTS WHICH ARE NOT SPECIFIED AS "AUTOMOTIVE GRADE" MAY ONLY BE USED IN AUTOMOTIVE APPLICATIONS AT USER'S OWN RISK.**

Resale of ST products with provisions different from the statements and/or technical features set forth in this document shall immediately void any warranty granted by ST for the ST product or service described herein and shall not create or extend in any manner whatsoever, any liability of ST.

ST and the ST logo are trademarks or registered trademarks of ST in various countries.

Information in this document supersedes and replaces all information previously supplied.

The ST logo is a registered trademark of STMicroelectronics. All other names are the property of their respective owners.

© 2011 STMicroelectronics - All rights reserved

STMicroelectronics group of companies

Australia - Belgium - Brazil - Canada - China - Czech Republic - Finland - France - Germany - Hong Kong - India - Israel - Italy - Japan - Malaysia - Malta - Morocco - Philippines - Singapore - Spain - Sweden - Switzerland - United Kingdom - United States of America

[www.st.com](http://www.st.com)