STEVAL-ILL055V1: 11 W offline LED drive with high power factor based on HVLED815PF (EU input range)

Introduction

The purpose of this document is to provide detailed information for the STEVAL-ILL055V1 offline LED evaluation board in order to aid the user in its use.

The application implemented in the board is an isolated SMPS, designed in high power factor flyback topology. It generates a 640 mA nominal output current capable of delivering up to 11 W output power, providing a cost-effective and space-saving solution.

This STEVAL-ILL055V1 is based on STMicroelectronics' HVLED815PF, a monolithic offline LED driver with primary-sensing and integrating an 800 V avalanche rugged power MOSFET and PWM controller in one package.

This document contains a basic technical description of the evaluation board (schematic diagram, transformer specification, PCB details and bill of material) as well as the most significant parameter measurements (load regulation, efficiency, standby behavior, EMI and thermal behavior data).

Figure 1. STEVAL-ILL055V1



Contents

1	Main characteristics	3
2	Schematic diagram	4
3	Bill of materials (BOM)	5
4	Transformer specification	7
5	Measurements	8
6	Revision history	11

1 Main characteristics

The main characteristics of the offline LED driver are listed below:

- Input:
 - Voltage: 185 – 264 Vac
 - Frequency: 45 – 55 Hz
- Output:
 - Current: 640 mA
 - Voltage: 6-LED module (blue or white)
 - a) Power factor
 - >0.9
- Efficiency
 - 84%
- PCB type and size:
 - FR4
 - Double layer
 - Copper thickness: 35 μ m
 - LED driver size: 17 x 55 mm
 - Board size: 34 x 88 mm
- Isolation
 - Isolated 2 kV / 4 mm isolation gap
- EMI
 - In accordance with EN55022 Class B

2 Schematic diagram

Figure 2. STEVAL-ILL055V1 circuit schematic

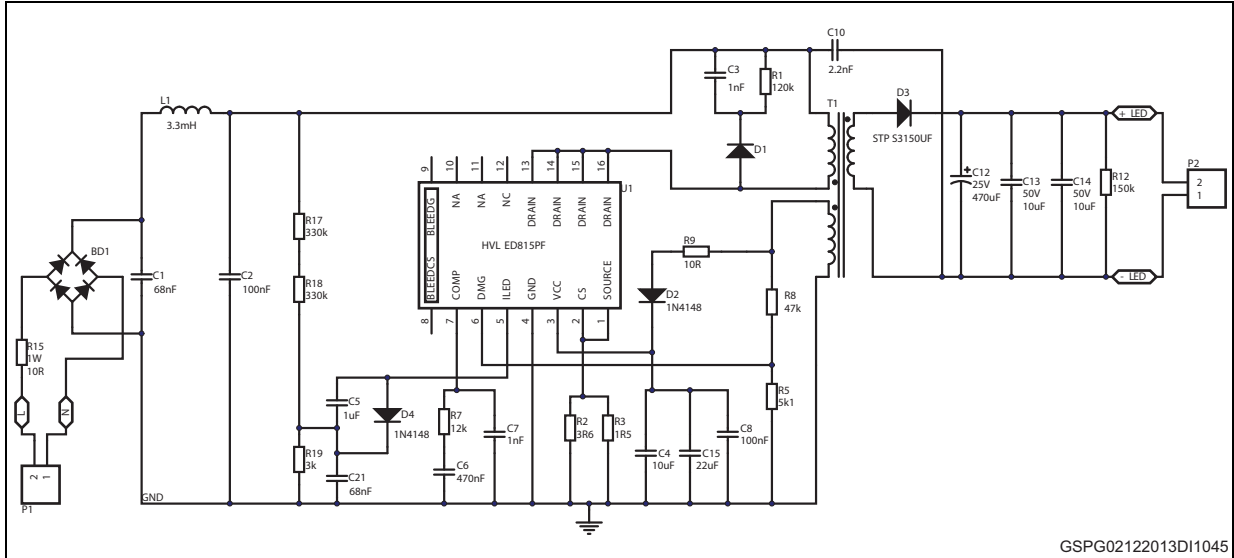

3 Bill of materials (BOM)

Table 1. BOM

Ref	Value	Package	Manufacturer	Part number
BD1	600V – 0.8A	Mini DIP	DIODES Inc.	HD06-T
C1	47nF – X2	DIP 5x11x13	Epcos	B32921C3683M
C2	100nF – X2	DIP 4x9x13	Epcos	B32921C3104M
C3	1nF – 630V- X7R	SMD 1206	Epcos	C3216X7R2J102K
C4	10uF -25V - X5R	SMD 0805	AVX	08053D106KAT2A
C5	1uF - 10V- X7R	SMD 0603	AVX	0603ZD105KAT2A
C6	470nF	SMD 0603	Multicomp	MCCA001174
C7	1nF	SMD 0603	Multicomp	MCCA000224
C8	100nF-25V	SMD 0603	Multicomp	MCCA000255
C10	2.2F – 250V	SMD 1808	Murata	GA355DR7GC222KY02
C12	470uF - 25V	SMD FK-G	Panasonic	EEEFK1E471P
C13	10uF -50V – X5R	SMD 1206	Epcos	C3216X5R1H106K
C14	10uF -50V – X5R	SMD 1206	Epcos	C3216X5R1H106K
C15	22uF - 25V - X5R	SMD 0805	Murata	GRM21BR61E226ME44L
C21	68nF – 10V	SMD 0603	AVX	06035C683KAT2A
D1	0.5A- 600V	SMD M-FLAT	TAIWAN SEM.	RSFJL
D2	1N4148	SOD-323	Vishay	1N4148WS-V-GS08
D3	3A – 150V	SMB FLAT	ST	STPS3150UF
D4	1N4148	SOD-323	Vishay	1N4148WS-V-GS08
L1	3.3mH		Coilcraft	LPS6235-335ML
R1	120k	SMD 1206	Panasonic	ERJP08F1203V
R2	3R6 – 1%	SMD 0805		
R3	1R5 – 1%	SMD 1206		
R5	5.1k – 1%	SMD 0805	Multicomp	MC 0.1W 0805 1% 5K1
R16	1k -1W	SMD 2512		
R7	12k	SMD 0603	Multicomp	MC 0.063W 0603 1% 12K
R8	47k – 1%	SMD 0805	Multicomp	MC 0.1W 0805 1% 47K
R9	10R	SMD 0805	Multicomp	MC 0.1W 0805 1% 10R
R12	150k	SMD 0603	Multicomp	MC 0.063W 0603 1% 150K
R15	10 Ohm – 2W	SMD 2515	Vishay	WSC251510R00FEA
R17	330k – 1%	SMD1206	Panasonic	ERJP08F3303V

Table 1. BOM (continued)

Ref	Value	Package	Manufacturer	Part number
R18	330k – 1%	SMD1206	Panasonic	ERJP08F3303V
R19	3k6 – 1%	SMD 0603	Panasonic	ERJ3EKF3601V
T1	EP13	SMD 10 pin	Coilcraft	PA6284-AL
U1	HVLED815PF	SO-16	ST	

4 Transformer specification

The transformer was developed in collaboration with the company Coilcraft, and is available through order number PA6284-AL.

- Core shape: EP13
- Core material: N87
- SMD bobbin, 8 pins
- Primary inductance: 1.4 mH

Table 2. Transformer specification

Layer	Name	No. turns	Start pin	Stop pin	Wire dia.	No. of layers
1	Primary	125	5	3	0.16	4
2	Secondary	17	10	6	2 x 0.2	2
3	Auxiliary	18	2	1	0.16	2

Figure 3. Windings of the transformer

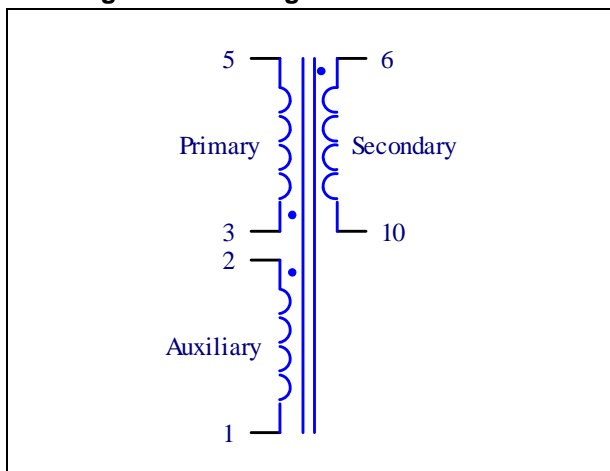
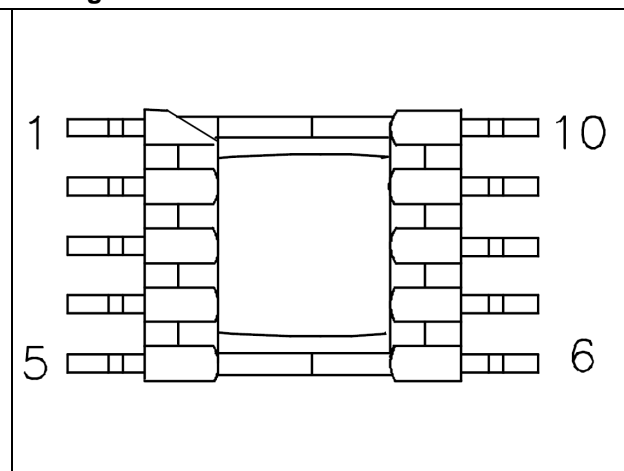

Figure 4. Bottom view of the transformer



5 Measurements

All measurements were conducted on the prototype board. The load was a 6-LED, 640 mA module.

Figure 5. Efficiency

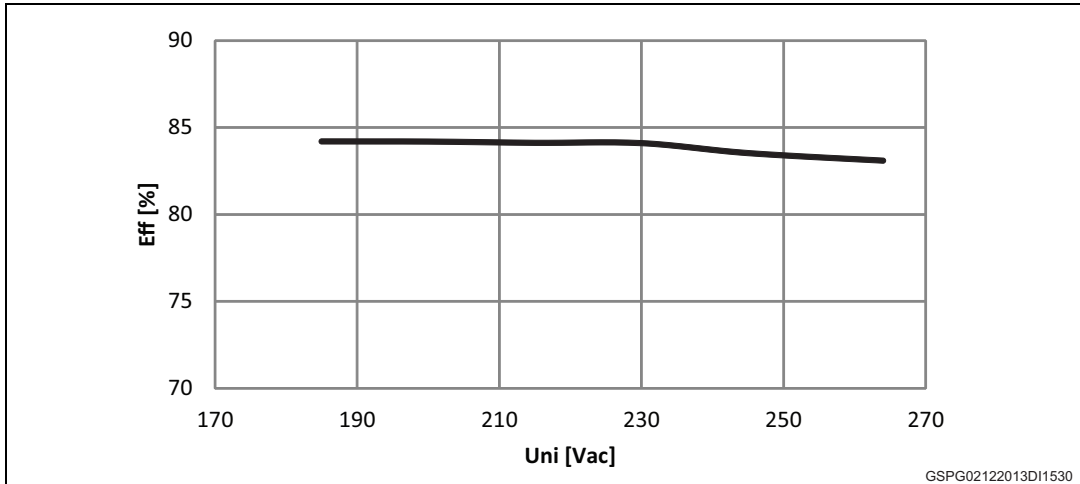

Figure 6. Power factor

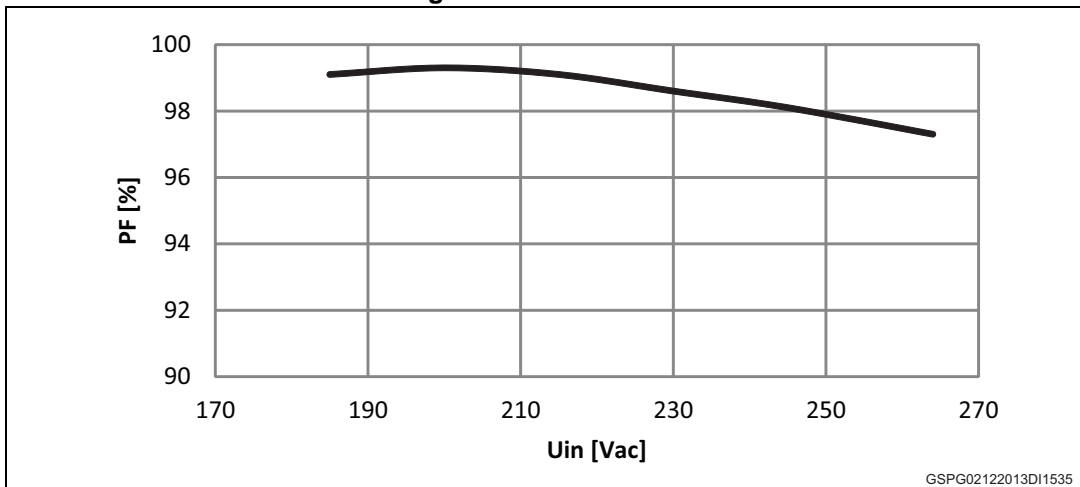

Figure 7. Output current

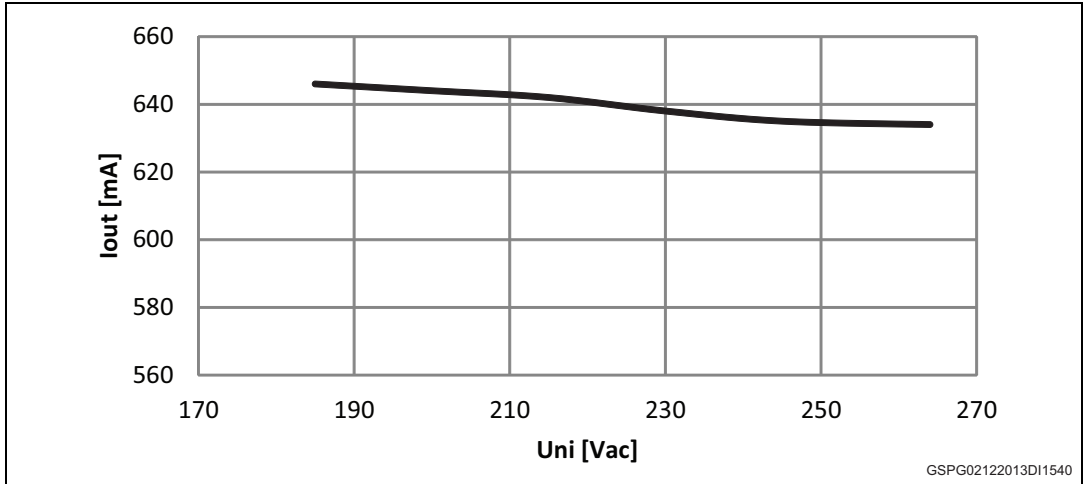

Figure 8. EMI measurement – quasi peak

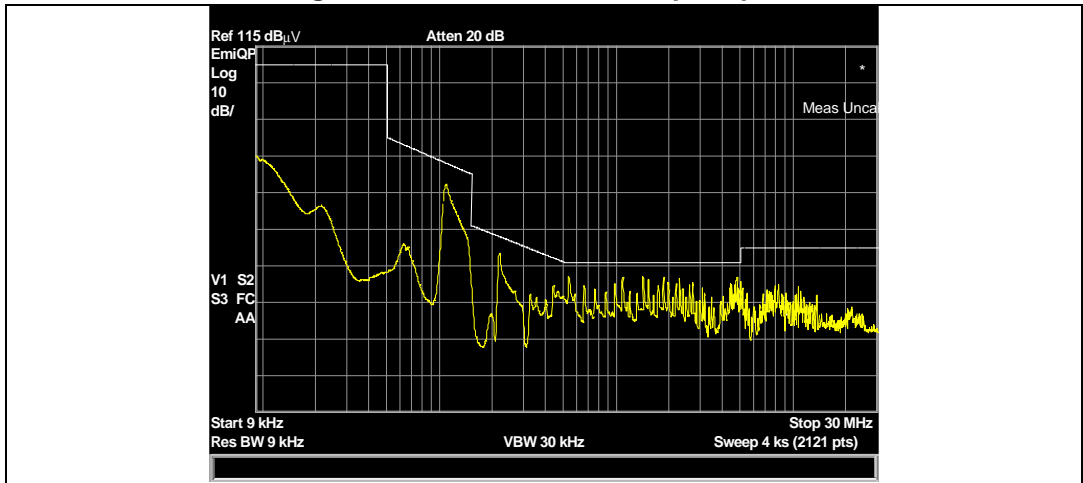

Figure 9. EMI measurement – average

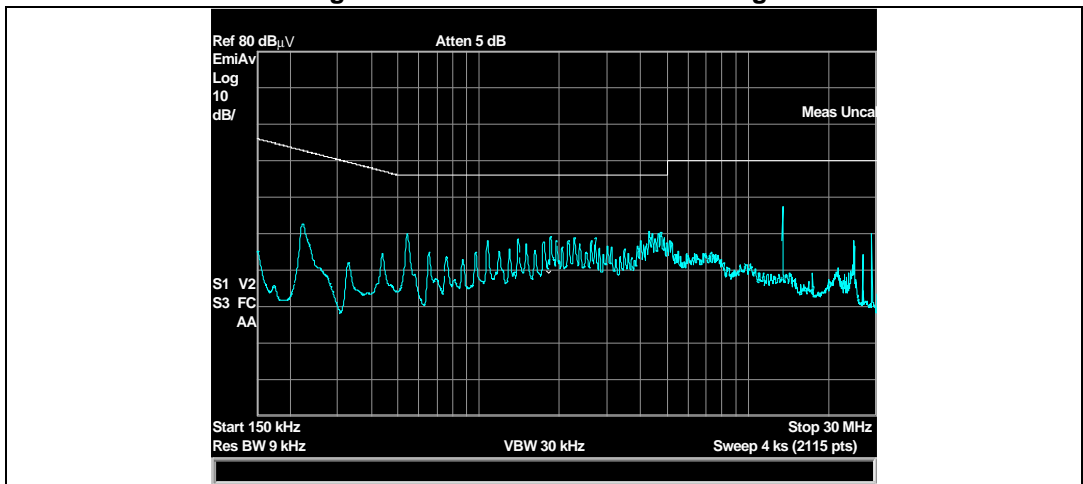

Figure 10. Thermal measurement – top side

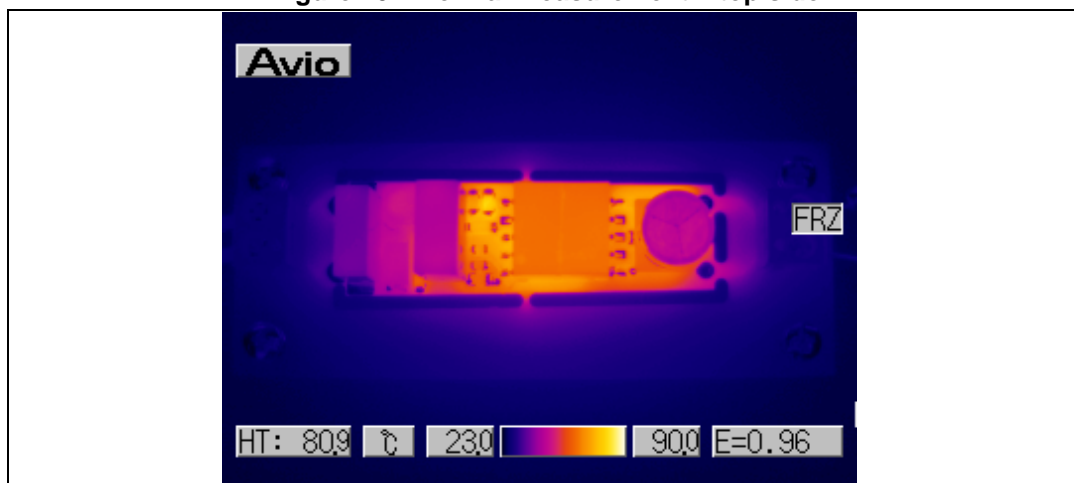
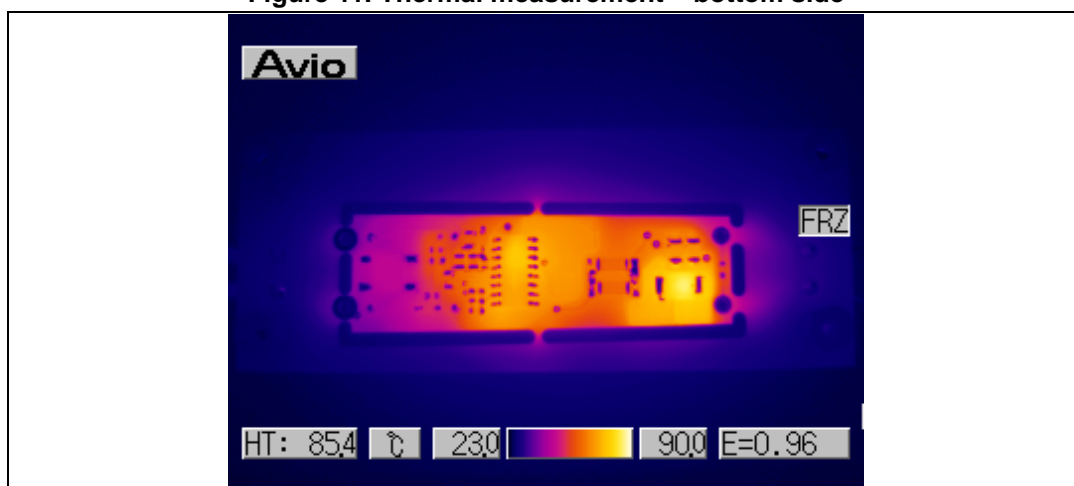

Figure 11. Thermal measurement – bottom side



6 Revision history

Table 3. Document revision history

Date	Revision	Changes
04-Jun-2014	1	Initial release.

Please Read Carefully:

Information in this document is provided solely in connection with ST products. STMicroelectronics NV and its subsidiaries ("ST") reserve the right to make changes, corrections, modifications or improvements, to this document, and the products and services described herein at any time, without notice.

All ST products are sold pursuant to ST's terms and conditions of sale.

Purchasers are solely responsible for the choice, selection and use of the ST products and services described herein, and ST assumes no liability whatsoever relating to the choice, selection or use of the ST products and services described herein.

No license, express or implied, by estoppel or otherwise, to any intellectual property rights is granted under this document. If any part of this document refers to any third party products or services it shall not be deemed a license grant by ST for the use of such third party products or services, or any intellectual property contained therein or considered as a warranty covering the use in any manner whatsoever of such third party products or services or any intellectual property contained therein.

UNLESS OTHERWISE SET FORTH IN ST'S TERMS AND CONDITIONS OF SALE ST DISCLAIMS ANY EXPRESS OR IMPLIED WARRANTY WITH RESPECT TO THE USE AND/OR SALE OF ST PRODUCTS INCLUDING WITHOUT LIMITATION IMPLIED WARRANTIES OF MERCHANTABILITY, FITNESS FOR A PARTICULAR PURPOSE (AND THEIR EQUIVALENTS UNDER THE LAWS OF ANY JURISDICTION), OR INFRINGEMENT OF ANY PATENT, COPYRIGHT OR OTHER INTELLECTUAL PROPERTY RIGHT.

ST PRODUCTS ARE NOT DESIGNED OR AUTHORIZED FOR USE IN: (A) SAFETY CRITICAL APPLICATIONS SUCH AS LIFE SUPPORTING, ACTIVE IMPLANTED DEVICES OR SYSTEMS WITH PRODUCT FUNCTIONAL SAFETY REQUIREMENTS; (B) AERONAUTIC APPLICATIONS; (C) AUTOMOTIVE APPLICATIONS OR ENVIRONMENTS, AND/OR (D) AEROSPACE APPLICATIONS OR ENVIRONMENTS. WHERE ST PRODUCTS ARE NOT DESIGNED FOR SUCH USE, THE PURCHASER SHALL USE PRODUCTS AT PURCHASER'S SOLE RISK, EVEN IF ST HAS BEEN INFORMED IN WRITING OF SUCH USAGE, UNLESS A PRODUCT IS EXPRESSLY DESIGNATED BY ST AS BEING INTENDED FOR "AUTOMOTIVE, AUTOMOTIVE SAFETY OR MEDICAL" INDUSTRY DOMAINS ACCORDING TO ST PRODUCT DESIGN SPECIFICATIONS. PRODUCTS FORMALLY ESCC, QML OR JAN QUALIFIED ARE DEEMED SUITABLE FOR USE IN AEROSPACE BY THE CORRESPONDING GOVERNMENTAL AGENCY.

Resale of ST products with provisions different from the statements and/or technical features set forth in this document shall immediately void any warranty granted by ST for the ST product or service described herein and shall not create or extend in any manner whatsoever, any liability of ST.

ST and the ST logo are trademarks or registered trademarks of ST in various countries.

Information in this document supersedes and replaces all information previously supplied.

The ST logo is a registered trademark of STMicroelectronics. All other names are the property of their respective owners.

© 2014 STMicroelectronics - All rights reserved

STMicroelectronics group of companies

Australia - Belgium - Brazil - Canada - China - Czech Republic - Finland - France - Germany - Hong Kong - India - Israel - Italy - Japan - Malaysia - Malta - Morocco - Philippines - Singapore - Spain - Sweden - Switzerland - United Kingdom - United States of America

www.st.com